

Xenotech, Inc.[®]

BRITELIGHT[®]

4000AR

SYSTEM MANUAL

REV 1.0
208/230V MB BALLAST W/PS
COPYRIGHT © 1996 Xenotech, Inc.

BRITELIGHT 4000AR SPECIFICATIONS	3
SYSTEM INSTALLATION	4
RECEIVING INSPECTION	5
UNPACKING	7
SYSTEM ASSEMBLY	8
LAMP HEAD ELECTRICAL CONNECTIONS	10
ELECTRICAL SERVICE INSTALLATION	14
SYSTEM OPERATION	16
CONTROL PANEL & SYSTEM OPERATION	18
LAMP OPERATION	20
SYSTEM ADJUSTMENTS	
GLOBING INSTRUCTIONS	21
INSTRUCTIONS FOR REMOVING AND INSTALLING A TYPE TH GLOBE IN A BL4000AR FIXTURE	23
DISASSEMBLY PROCEDURE IF THERE IS NO GLOBE INSTALLED IN THE FIXTURE	24
DISASSEMBLY PROCEDURE IF THERE IS A GLOBE IS INSTALLED IN THE FIXTURE	25
REMOVING A FROZEN GLOBE	26
ASSEMBLY PROCEDURE	27
FOCUS AND X-Y ADJUSTMENT INSTRUCTIONS	29
OUTPUT POWER ADJUSTMENT PROCEDURES	31
CIRCUIT DESCRIPTIONS	33
LAMP HEAD IGNITOR CIRCUIT	35
LAMP HEAD SAFETY INTERLOCK CIRCUIT	35
4 KW BALLAST CIRCUIT	36
AUTO STRIKE CIRCUIT	39
SYSTEM COOL DOWN CIRCUIT	38
SYSTEM PART LISTS	40
LAMP HEAD MAIN BULKHEAD ASSEMBLY	41
LAMP HEAD CORE ASSEMBLY	41
LAMP HEAD COVERS	41
BALLAST COVER ASSEMBLY	43
BALLAST CONTROL PANEL ASSEMBLY	44
BALLAST CONTROL PRINTED CIRCUIT BOARD ASSEMBLY	45
BALLAST CORE ASSEMBLY	47
ILLUSTRATIONS AND SCHEMATICS	
AZIMUTH ADJUSTMENT RANGE (FIG 1)	6
BALLAST LEFT SIDE VIEW (FIG 2)	9
BALLAST FRONT VIEW W/ HOOKUP INFORMATION (FIG 3)	10
SYSTEM SCHEMATIC (FIG 4)	11
SYSTEM CONTROL PANEL (FIG 5)	17
FRONT LAMP HOLDER ASSEMBLY (FIG 6)	22
BALLAST REAR VIEW (FIG 7)	30
LAMP HEAD SCHEMATIC (FIG 8)	34
BALLAST SCHEMATIC (FIG 9)	36
CONTROL PCB SCHEMATIC (FIG 10)	38
LAMP HEAD IGNITOR COMPONENT LOCATION (FIG 11)	40
BALLAST CONTROL COMPONENT LOCATION (FIG 12)	
CONTROL PCB COMPONENT LOCATION (FIG 13)	45
BALLAST CORE COMPONENT LOCATION (FIG 14)	46

BRITELIGHT 4000AR SPECIFICATIONS

POWER SUPPLY

MAIN POWER INPUT

INPUT VOLTAGE: 208/230 VAC.
INPUT CURRENT: 20 AMPS
PHASE: THREE
FREQUENCY: 60/50 HZ.

SYSTEM CONTROL INPUT

SWITCH CLOSURE NORMALLY OPEN
UNIT SOURCES 120 VAC 5 AMPS MAX.

OUTPUTS LAMP

OUTPUT VOLTAGE: 250 - 35 VDC.
OUTPUT CURRENT: 60 - 145 ADC.
OUTPUT RIPPLE: LESS THAN 5% P-P
OUTPUT ADJ. RANGE: 16 STEPS

SCROLLER/DOUSER

OUTPUT VOLTAGE 24 VDC.
OUTPUT CURRENT 6 ADC.

LAMP HEAD

LAMP INPUT

LAMP VOLTAGE: 31 - 32.5 VDC.
LAMP CURRENT: 120 - 135 ADC.
LIGHT OUTPUT: 395 MILLION PBCP.

COOLING & IGNITION CIRCUIT INPUT

INPUT VOLTAGE: 120 VAC.
INPUT CURRENT: 5 AMPS PEAK
PHASE: SINGLE
FREQUENCY: 60 HZ.

SYSTEM OPERATION TEMPERATURE RANGE

NOMINAL AMBIENT: 0° - 122° F.

SYSTEM WEIGHT

560 LBS.

SYSTEM INSTALLATION

BRITELIGHT 4000AR INSTALLATION INSTRUCTIONS

NOTE

THE BL4000AR SYSTEM SHOULD BE INSTALLED BY AN ELECTRICAL CONTRACTOR FOLLOWING ALL APPLICABLE ELECTRICAL AND BUILDING CODES FOR THE INSTALLATION SITE.

RECEIVING

IMMEDIATELY INSPECT ALL CRATES, BOXES, AND PALLETIZED EQUIPMENT FOR OUTWARD SIGNS OF DAMAGE AND ABUSE. IF DAMAGE IS PRESENT, NOTE THIS ON THE SHIPPING DOCUMENTS BEFORE ACCEPTING SHIPMENT AND IMMEDIATELY INSPECT THE ENTIRE SHIPMENT FOR HIDDEN DAMAGE. NOTIFY SHIPPING COMPANY AS SOON AS POSSIBLE IF EQUIPMENT DAMAGE IS FOUND.

EQUIPMENT INITIAL VISUAL INSPECTION

AFTER UNPACKING AND BEFORE ASSEMBLING THE SYSTEM, CAREFULLY INSPECT THE SYSTEM FOR LOOSENING OF MECHANICAL AND ELECTRICAL CONNECTIONS THAT MAY HAVE OCCURRED DURING SHIPPING. THE FOLLOWING IS A LISTING OF SOME OF THE MORE IMPORTANT PLACES TO CHECK. A THOROUGH INSPECTION OF THE SYSTEM MAY PREVENT OR IDENTIFY MANY POTENTIAL PROBLEMS AND HELP AVOID HOURS OF TROUBLE SHOOTING AFTER INSTALLING THE SYSTEM.

LAMP HEAD

1. REMOVE FRONT COWL
2. CHECK THE FRONT SPIDER MOUNTING FOR LOOSE OR MISSING PARTS AT THE END OF THE THREE ARMS.
3. CHECK THE HIGH CURRENT ELECTRICAL CONNECTIONS ON THE FRONT SPIDER FOR LOOSE CONNECTIONS.
4. CHECK THE REAR LAMP MOUNTING RECEIVER ASSEMBLY (LOCATED IN THE HOLE AT THE REAR OF THE REFLECTOR) FOR LOOSE OR MISSING PARTS.
5. REMOVE THE TOP COVER. (COVER WITH WARNINGS & LOGO)
6. CHECK ALL HIGH CURRENT ELECTRICAL CONNECTIONS FOR LOOSE HARDWARE.
7. VISUALLY INSPECT LAMP HEAD FOR ANY SIGNS OF LOOSE PARTS OR DAMAGE.

BALLAST (BASE)

1. REMOVE SIDE PANELS
2. CHECK BALLAST CORE MOUNTING HARDWARE.
3. CHECK BALLAST CORE POWER ADJUSTMENT TAP TERMINAL BLOCKS (TB1-6) FOR LOOSE CONNECTING SCREWS.
4. CHECK BALLAST CORE INPUT TERMINAL BLOCK (TB8) FOR LOOSE CONNECTING SCREWS. (LOCATED NEXT TO POWER CONTACTOR)
5. CHECK BALLAST CORE CONTACTOR (K1) FOR LOOSE CONNECTING SCREWS.
6. CHECK THE BALLAST CORE OUTPUT WIRING FOR LOOSE OR MISSING HARDWARE AT THE OUTPUT LUGS ON THE HEATSINKS, AT THE OUTPUT CURRENT SHUNT, AND AT THE OUTPUT TERMINAL BLOCK (TB10)..
7. CHECK CONTROL CIRCUIT BOARD TERMINAL BLOCKS FOR LOOSE CONNECTIONS AND THE THREE RELAY LOCATIONS FOR LOOSE OR MISSING RELAYS.
8. VISUALLY INSPECT BALLAST CORE FOR ANY SIGNS OF LOOSE PARTS OR DAMAGE.

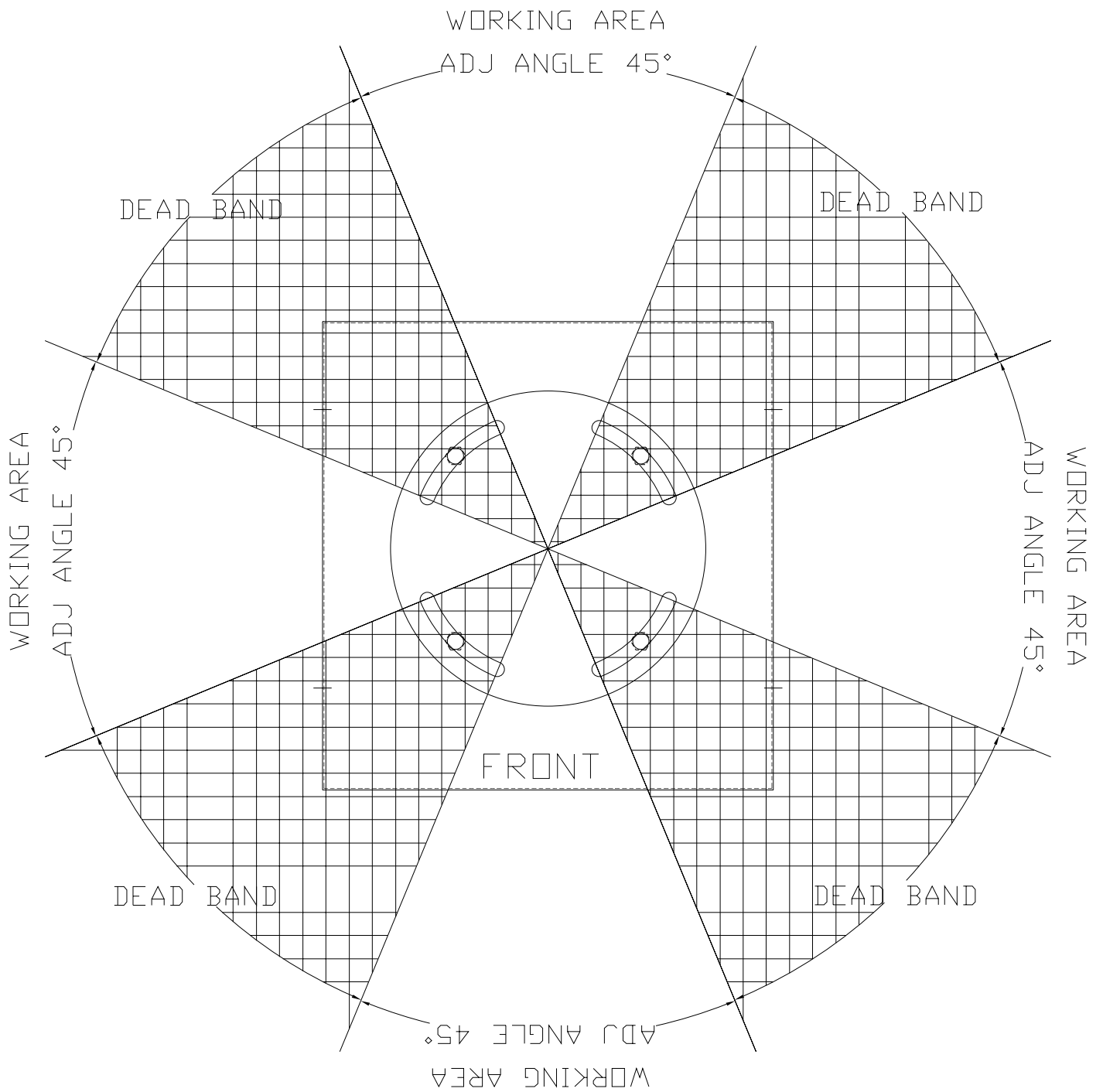

FIG-1 AZIMUTH ADJUSTMENT RANGE

UNPACKING

BALLAST

NOTE

DELIVER THE SYSTEM COMPONENTS TO THE LOCATION THEY WILL BE INSTALLED PRIOR TO REMOVING THEM FROM THEIR SHIPPING CONTAINERS AND PALLETS.

1. REMOVE ANY PACKING MATERIAL FROM THE OUTSIDE OF THE BALLAST UNIT AND REMOVE THE UNIT FROM ITS SHIPPING PALLET BY REMOVING THE 4 RETAINING BOLTS FROM THE BASE FOOTINGS AND LIFTING THE UNIT FROM THE PALLET.
2. POSITION THE BALLAST UNIT IN THE LOCATION THAT IT WILL BE OPERATING AND CHECK THE SYSTEM FOR STABILITY. IT IS RECOMMENDED THAT THE SYSTEM BE BOLTED DOWN TO THE MOUNTING SURFACE. IF THE SURFACE IS UNEVEN IT MAY BE NECESSARY TO SHIM THE FOOTINGS OF THE BASE UNIT TO STABILIZE THE SYSTEM.
3. BEFORE INSTALLING THE ELECTRICAL AND CONTROL SERVICE WIRING, THE BALLAST UNIT SHOULD BE POSITIONED IN THE ORIENTATION THAT IT WILL BE USED AND SECURELY FASTENED TO ITS MOUNTING SURFACE. ALLOW ADEQUATE SPACE (4 FEET MINIMUM) AROUND THE SYSTEM FOR VENTILATION, SYSTEM SERVICING.

LAMP HEAD

1. REMOVE ANY PACKING MATERIAL FROM THE OUTSIDE OF THE LAMP HEAD UNIT AND REMOVE THE UNIT FROM ITS SHIPPING PALLET BY REMOVING THE 4 RETAINING BOLTS FROM THE BASE PLATE AND LIFTING THE UNIT FROM THE PALLET.
2. PROCEED TO THE SYSTEM ASSEMBLY SECTION FOR LAMP HEAD MOUNTING INSTRUCTIONS.

SYSTEM ASSEMBLY

TWO PIECE SYSTEM

THE LAMP HEAD IS MOUNTED REMOTELY ON A SURFACE AT SOME DISTANCE AWAY FROM THE BALLAST AND THE ELECTRICAL CONNECTIONS BETWEEN THE LAMP HEAD AND BALLAST MAY BE VIA WIRING SUPPLIED BY A SOURCE OTHER THAN XENOTECH INC.

LAMP HEAD MOUNTING

REMOTE LAMP HEAD (TWO PIECE SYSTEM)

NOTE

PRIOR TO INSTALLING THE LAMP HEAD 5/8 INCH THREADED STUDS MOUNTED ON A 10 INCH SQUARE PATTERN WITH A WORKING HEIGHT OF 1 1/4 INCHES MINIMUM SHOULD BE INSTALLED AT THE LOCATION THE LAMP HEAD WILL BE MOUNTED.

NOTE

SOME THOUGHT AND PLANING SHOULD BE GIVEN TO THE DIRECTION THE LAMP HEAD WILL BE POINTING DURING OPERATION, BEFORE LOCATING AND INSTALLING THE LAMP HEAD MOUNTING STUDS. THERE WILL BE 45° OF AZIMUTH ADJUSTMENT AVAILABLE BETWEEN THE MOUNTING STUDS AND THE LAMP HEAD ONCE THE LAMP HEAD IS MOUNTED ON THE STUDS. THIS RANGE OF MOTION SHOULD BE CONSIDERED WHEN SELECTING THE INSTALLATION ORIENTATION OF THE MOUNTING STUDS. THE PREFERRED POSITION FOR THE MOUNTING STUDS SHOULD BE WITH THE SIDE OF THE SQUARE MOUNTING PATTERN FACING THE DIRECTION THE SEARCH LIGHT WILL BE SHINING WHEN IN OPERATION. (SEE FIGURE 1)

1. REMOVE THE LAMP HEAD FROM THE SHIPPING PALLET, PLACE IT OVER THE MOUNTING STUDS THAT HAVE BEEN INSTALLED ON THE SURFACE THAT THE LAMP HEAD WILL BE MOUNTED ON AND ROTATE THE HEAD SO THE LENS POINTS IN THE DIRECTION THAT IT WILL BE NORMALLY OPERATING IN.
3. SECURE THE LAMP HEAD TO THE MOUNTING SURFACE USING THE APPROPRIATE HARDWARE FOR THE INSTALLED STUDS. DO NOT TIGHTEN THE HARDWARE UNTIL THE SYSTEM IS OPERATIONAL AND HAS BEEN ADJUSTED.
4. PROCEED TO THE LAMP HEAD ELECTRICAL CONNECTION REMOTE LAMP HEAD SECTION.

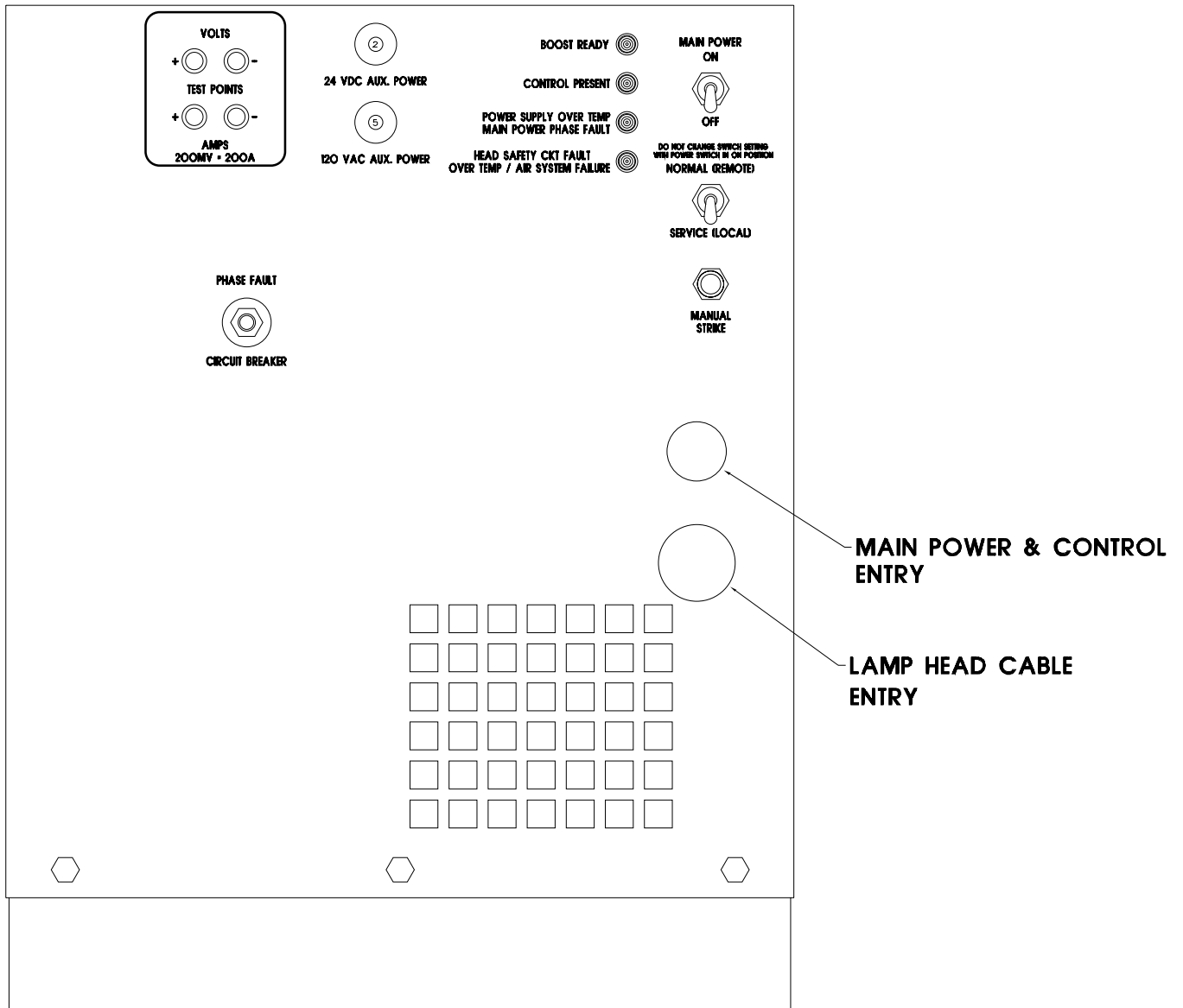

FIG-2 BALLAST LEFT SIDE VIEW

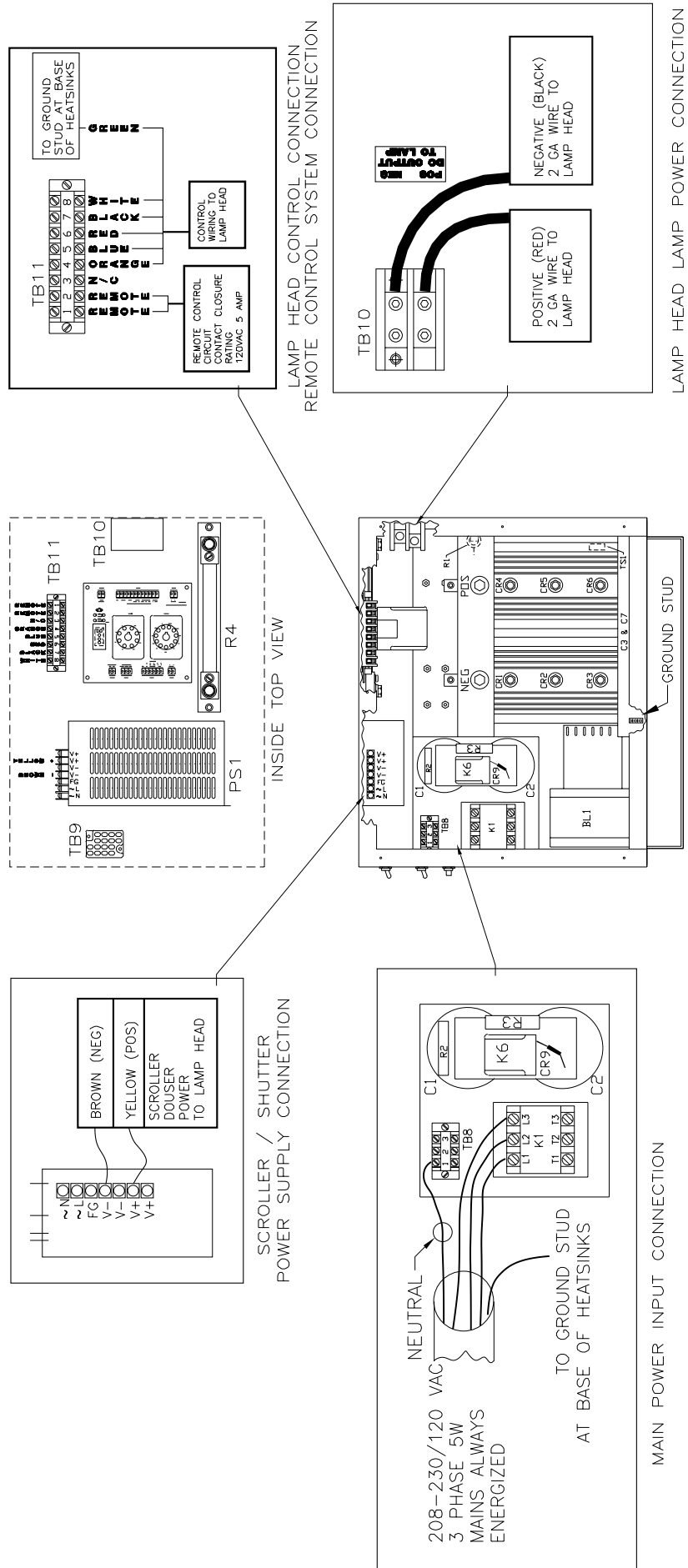
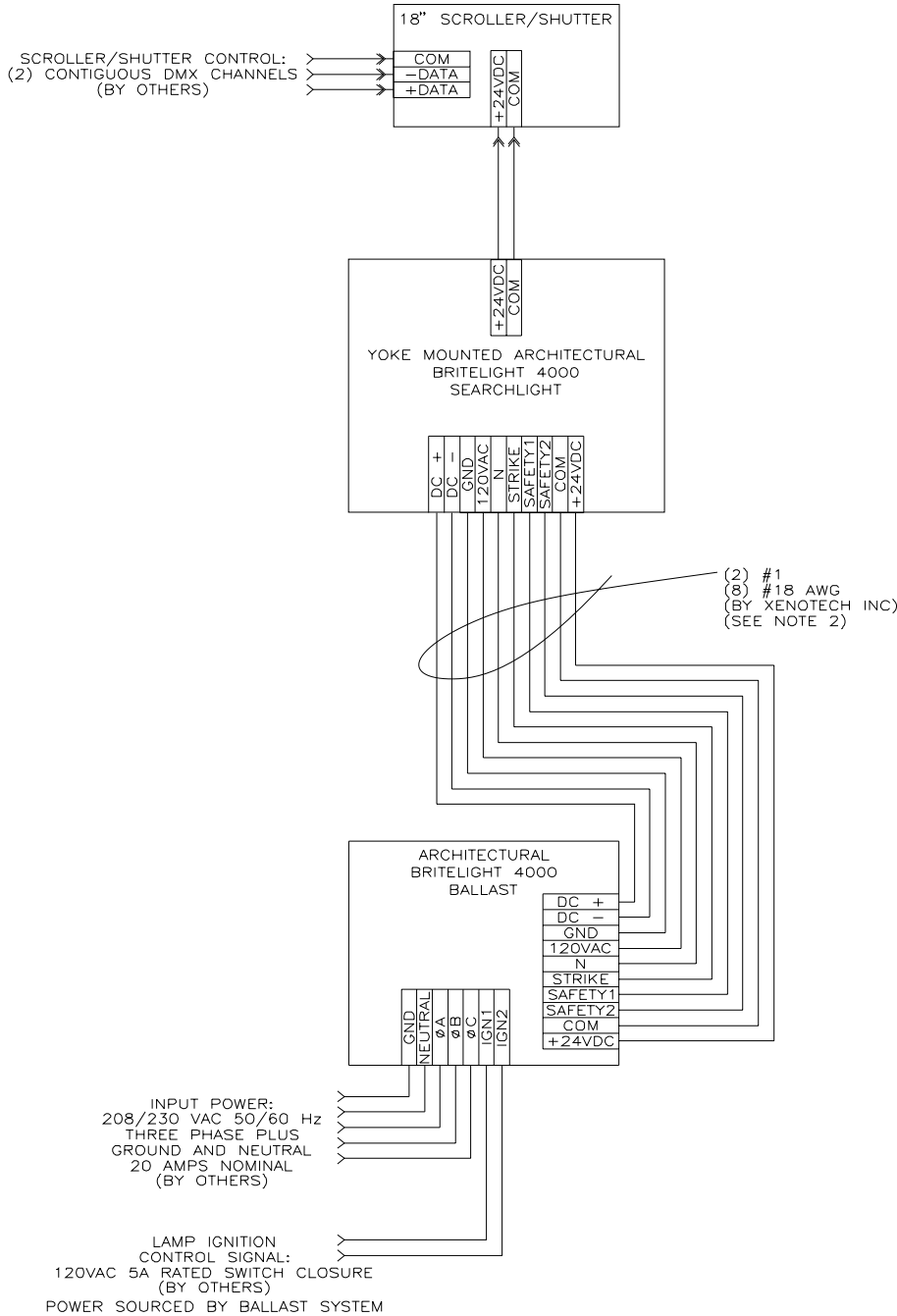

FIG-3 BALLAST FRONT VIEW W/ HOOKUP INFORMATION



18" SCROLLER/SHUTTER CONTROL CONNECTIONS			
5 PIN XLR TERMINAL DESIGNATIONS	FUNCTION	WIRE TYPE	COLOR
1	COM	BELDEN 9680	DRAIN
2	-DATA	BELDEN 9680	ORANGE
3	+DATA	BELDEN 9680	W/ORANGE
4	NC	BELDEN 9680	GREEN
5	NC	BELDEN 9680	W/GREEN

18" SCROLLER/SHUTTER POWER CONNECTIONS			
3 PIN XLR TERMINAL DESIGNATIONS	FUNCTION	WIRE TYPE	COLOR
1	COM	BELDEN 9486	BLACK
2	+24VDC	BELDEN 9486	RED
3	NC	-	-

BRITELIGHT 4000 SEARCHLIGHT CONNECTIONS			
DIGITAL DESIGNATIONS	FUNCTION	WIRE TYPE	COLOR
1	DC +	1	RED
2	DC -	1	BLACK
3	GND	18 AWG	GREEN
4	120VAC	18 AWG	BLACK
5	N	18 AWG	WHITE
6	STRIKE	18 AWG	ORANGE
7	SAFETY1	18 AWG	RED
8	SAFETY2	18 AWG	BLUE
9	COM	18 AWG	BROWN
10	+24VDC	18 AWG	YELLOW

BRITELIGHT 4000 BALLAST OUTPUT CONNECTIONS			
TERMINAL DESIGNATIONS	FUNCTION	WIRE TYPE	CONTRACTOR WIRE COLOR
1	DC +	1/Ø	
2	DC -	1/Ø	
3	GND	18 AWG	
4	120VAC	18 AWG	
5	N	18 AWG	
6	STRIKE	18 AWG	
7	SAFETY1	18 AWG	
8	SAFETY2	18 AWG	
9	COM	18 AWG	
10	+24VDC	18 AWG	

BRITELIGHT 4000 BALLAST INPUT CONNECTIONS			
TERMINAL DESIGNATIONS	FUNCTION	WIRE TYPE	CONTRACTOR WIRE COLOR
11	GND		
12	NEUTRAL		
13	ØA		
14	ØB		
15	ØC		
16	IGN 1		
17	IGN 2		

FIG-4 SYSTEM SCHEMATIC

LAMP HEAD ELECTRICAL CONNECTIONS

REMOTE LAMP HEAD USING SUPPLIED LAMP HEAD CABLE

1. REMOVE THE LOCK NUT FROM THE CORD GRIP LOCATED AT THE FREE END OF THE LAMP HEAD POWER CABLE ASSEMBLY.
2. FEED THE LAMP HEAD POWER CABLE THROUGH THE HOLE LOCATED AT THE LEFT SIDE OF THE BALLAST UNIT UNTIL THE CORD GRIP IS SEATED IN THE HOLE. (SEE FIGURE 2)
3. REPLACE THE LOCK NUT AND TIGHTEN.

WARNING

EXTREME CARE MUST BE TAKEN WHEN CONNECTING THE LAMP HEAD DC INPUT WIRES TO THE BALLAST OUTPUT. REVERSING THE POLARITY OF THE LEADS WILL CAUSE IMMEDIATE DAMAGE TO THE XENON LAMP WHEN THE LAMP IS LIT.

NOTE

THE NEXT STEPS ARE PERFORMED AT THE FRONT OF THE BALLAST.

ROUTE THE LAMP HEAD WIRING SO THAT IT RUNS ALONG THE FRONT OF THE BALLAST CORE AND ALONG THE LEFT SIDE OF THE BALLAST AS NECESSARY.

DO NOT ALLOW THE WIRES TO CONTACT SHARP EDGES ON THE BALLAST CORE.

4. CONNECT THE LARGE RED LEAD (POSITIVE) TO THE OUTPUT TERMINAL BLOCK (TB10) LUG MARKED POS LOCATED ON THE RIGHT SIDE OF THE BALLAST. (SEE FIGURE 3)
5. CONNECT THE LARGE BLACK LEAD (NEGATIVE) TO THE OUTPUT TERMINAL BLOCK (TB10) LUG MARKED NEG LOCATED ON THE RIGHT SIDE OF THE BALLAST. (SEE FIGURE 3)
6. CONNECT THE BROWN WIRE TO THE NEGATIVE OUTPUT TERMINAL ON THE SCROLLER/SHUTTER 24V DC POWER SUPPLY (PS1) LOCATED ON THE TOP PANEL AT THE LEFT SIDE WHEN FACING THE FRONT OF THE BALLAST. (SEE FIGURE 3)
7. CONNECT THE YELLOW WIRE TO THE POSITIVE OUTPUT TERMINAL ON THE SCROLLER/SHUTTER 24V DC POWER SUPPLY (PS1) LOCATED ON THE TOP PANEL AT THE LEFT SIDE WHEN FACING THE FRONT OF THE BALLAST. (SEE FIGURE 3)

NOTE

**THE COLOR CODE FOR THE FOLLOWING CONNECTIONS ARE MARKED ON THE TOP OF THE BALLAST AT TB11.
(SEE FIGURE 3)**

9. CONNECT THE WHITE WIRE TO TB11 TERMINAL 8.
10. CONNECT THE BLACK WIRE TO TB11 TERMINAL 7.
11. CONNECT THE RED WIRE TO TB11 TERMINAL 6.
12. CONNECT THE BLUE WIRE TO TB11 TERMINAL 5.
13. CONNECT THE ORANGE WIRE TO TB11 TERMINAL 4.
14. CONNECT THE GREEN WIRE TO THE GROUND STUD LOCATED ON THE BALLAST CORE AT THE LOWER LEFT OF THE HEATSINKS.

LAMP HEAD ELECTRICAL CONNECTIONS

REMOTE LAMP HEAD USING EXTENDED WIRING SYSTEM

NOTE

THE INTERCONNECTING WIRING AND HARDWARE FOR THIS SECTION OF THE INSTALLATION IS PROVIDED BY THE ELECTRICAL CONTRACTOR OR OTHERS AT THE INSTALLATION SITE. THIS INFORMATION IS PROVIDED AS A GENERAL REFERENCE. ALL INSTALLATION MATERIALS AND METHODS MUST MEET THE REQUIREMENTS OF ALL APPLICABLE CODES AND REGULATIONS FOR THE SPECIFIC INSTALLATION LOCATION.

IN THE FOLLOWING PROCEDURE IT IS ASSUMED THAT COLOR CODED WIRING MATCHING THE LAMP HEAD POWER CABLE ASSEMBLY WILL BE USED TO EXTEND THE CONNECTIONS BETWEEN THE LAMP HEAD AND BALLAST UNIT. IF OTHER IDENTIFYING METHODS ARE USED SUBSTITUTE THE REFERENCES ACCORDINGLY.

MINIMUM WIRE REQUIREMENTS AT MAXIMUM 50 FOOT RUN.

NOTE

CONTACT XENOTECH INC. FOR REQUIRED WIRE SIZES FOR RUNS LONGER THAN 50 FEET BETWEEN BALLAST UNIT AND LAMP HEAD.

FUNCTION	SIZE	RATING	COLOR	OTHER MARKING
LAMP POWER				
POSITIVE LAMP POWER	2	105°C 300V	RED	
NEGATIVE LAMP POWER	2	105°C 300V	BLACK	
CONTROL				
NEUTRAL	18	105°C 600V	WHITE	
COOLING FAN HOT	18	105°C 600V	BLACK	
SAFETY CKT FEED	18	105°C 600V	RED	
SAFETY CKT RETURN	18	105°C 600V	BLUE	
IGNITOR HOT	18	105°C 600V	ORANGE	
GROUND	18	105°C 600V	GREEN	
SCROLLER/SHUTTER POWER				
24V DC NEGATIVE	16	105°C 600V	BROWN	
24V DC POSITIVE	16	105°C 600V	YELLOW	

1. AFTER MOUNTING THE LAMP HEAD ROUTE THE LAMP HEAD CABLE INTO AN APPROPRIATELY SIZED WEATHER PROOF JUNCTION BOX.

WARNING

EXTREME CARE MUST BE TAKEN WHEN MAKING CONNECTIONS TO THE LAMP HEAD DC INPUT WIRES TO THE BALLAST OUTPUT. REVERSING THE POLARITY OF THE LEADS WILL CAUSE IMMEDIATE DAMAGE TO THE XENON LAMP WHEN THE LAMP IS LIT.

2. CONNECT THE RED 2 AWG LAMP POWER WIRE TO THE WIRE BEING USED TO EXTEND THE POSITIVE CABLE RUN.
3. CONNECT THE BLACK 2 AWG LAMP POWER WIRE TO THE WIRE BEING USED TO EXTEND THE NEGATIVE CABLE RUN.
4. CONNECT THE SIX CONTROL WIRES TO THEIR RESPECTIVE WIRES BEING USED TO EXTEND THE CABLE RUN.
5. CONNECT THE TWO SCROLLER/SHUTTER 24 VDC POWER WIRES TO THEIR RESPECTIVE WIRES BEING USED TO EXTEND THE CABLE RUN.

WARNING

EXTREME CARE MUST BE TAKEN WHEN CONNECTING THE LAMP HEAD DC INPUT WIRES TO THE BALLAST OUTPUT. REVERSING THE POLARITY OF THE LEADS WILL CAUSE IMMEDIATE DAMAGE TO THE XENON LAMP WHEN THE LAMP IS LIT.

NOTE

THE NEXT STEPS ARE PREFORMED AT THE FRONT OF THE BALLAST.

ROUTE THE LAMP HEAD WIRING SO THAT IT RUNS ALONG THE BACK OF THE BALLAST CORE AND ALONG THE LEFT SIDE OF THE BALLAST AS NECESSARY.

DO NOT ALLOW THE WIRES TO CONTACT SHARP EDGES ON THE BALLAST CORE.

6. CONNECT THE LARGE RED 2 AWG LEAD (POSITIVE) TO THE OUTPUT TERMINAL (TB10) BLOCK LUG MARKED POS LOCATED ON THE RIGHT SIDE OF THE BALLAST. (SEE FIGURE 3)
7. CONNECT THE LARGE BLACK 2 AWG LEAD (NEGATIVE) TO THE OUTPUT TERMINAL (TB10) BLOCK LUG MARKED NEG LOCATED ON THE RIGHT SIDE OF THE BALLAST. (SEE FIGURE 3)
8. CONNECT THE BROWN WIRE TO THE NEGATIVE OUTPUT TERMINAL ON THE SCROLLER/SHUTTER 24V DC POWER SUPPLY LOCATED ON THE TOP PANEL AT THE LEFT SIDE WHEN FACING THE FRONT OF THE BALLAST. (SEE FIGURE 3)
9. CONNECT THE YELLOW WIRE TO THE POSITIVE OUTPUT TERMINAL ON THE SCROLLER/SHUTTER 24V DC POWER SUPPLY LOCATED ON THE TOP PANEL AT THE LEFT SIDE WHEN FACING THE FRONT OF THE BALLAST.

NOTE

THE COLOR CODE FOR THE FOLLOWING CONNECTIONS ARE MARKED ON THE TOP OF THE BALLAST AT TB11. (SEE FIGURE 3)

10. CONNECT THE WHITE WIRE TO TB11 TERMINAL 8.
11. CONNECT THE BLACK WIRE TO TB11 TERMINAL 7.
12. CONNECT THE RED WIRE TO TB11 TERMINAL 6.
13. CONNECT THE BLUE WIRE TO TB11 TERMINAL 5.
14. CONNECT THE ORANGE WIRE TO TB11 TERMINAL 4.
15. CONNECT THE GREEN WIRE TO THE GROUND STUD LOCATED ON THE BALLAST CORE AT THE LOWER LEFT OF THE HEATSINKS.

ELECTRICAL SERVICE INSTALLATION

THIS SYSTEM HAS BEEN CONFIGURED FOR 208-230/120 VAC 3 PHASE 5 WIRE 20 AMP 50/60 HZ MAINS.

WARNING

FOR PROPER OPERATION OF THIS SYSTEM THE MAINS SHOULD REMAIN ON AT ALL TIMES AND NOT BE USED TO TURN THE SYSTEM ON AND OFF DURING NORMAL OPERATION.

1. INSTALL MAIN POWER WIRING TO SYSTEM AS REQUIRED BY LOCAL CODES AND REGULATIONS.
2. CONNECT THE THREE MAIN HOT LINES TO THE THREE TOP CONTACTOR (K1) TERMINALS LOCATED ON THE LEFT FRONT OF THE BALLAST CORE. (SEE FIGURE 3)
3. CONNECT THE NEUTRAL LINE TO THE NUMBER ONE POSITION ON THE TERMINAL BLOCK (TB8) LOCATED ABOVE THE POWER CONTACTOR (K1). (SEE FIGURE 3)
4. CONNECT THE GROUND LINE TO THE GROUND STUD LOCATED ON THE BALLAST CORE AT THE LOWER LEFT OF THE HEATSINKS. (SEE FIGURE 3)

SYSTEM BALLAST POWER REMOTE CONTROL

NOTE

THE SYSTEM BALLAST POWER REMOTE CONTROL LINE SHOULD BE CONFIGURED TO SUPPLY AN ISOLATED CLOSED CIRCUIT WHEN THE SYSTEM IS ON AND AN OPEN CIRCUIT WHEN THE SYSTEM IS OFF.

MINIMUM CONTACT RATING SHOULD BE 5 AMPS 120 VAC.

MINIMUM WIRE REQUIREMENTS 18 GAGE 600 VOLT 105°C.

THE BALLAST CONTROL CIRCUIT WILL SOURCE 120 VAC FROM THE CONTROL PRINTED CIRCUIT BOARD TO THE SYSTEM REMOTE CONTROL LINE THROUGH TB11.

WARNING

THIS CIRCUIT IS POWERED FROM THE BALLAST CONTROL PRINTED CIRCUIT BOARD AND SHOULD NOT BE ENERGIZED BY ANY OTHER POWER SOURCE.

1. INSTALL WIRING TO SYSTEM AS REQUIRED BY LOCAL CODES AND REGULATIONS.
2. CONNECT THE TWO POWER REMOTE CONTROL WIRES FROM THE CONTROL DEVICE TO THE REMOTE CONTROL INPUT TERMINALS (TB1 1-1 & 2). (SEE FIGURE 3)

THE SYSTEM INSTALLATION IS NOW BE COMPLETE.

CHECK THAT THE BALLAST CORE PHASE LOSS CIRCUIT BREAKER LOCATED AT THE LEFT SIDE OF THE BALLAST IS PRESSED IN. (SEE FIGURE 6)

GO TO THE LAMP INSTALLATION SECTION.

REFER TO THE APPROPRIATE SECTIONS OF THE MANUAL FOR THE PROPER ADJUSTMENT PROCEDURES.

SYSTEM OPERATION

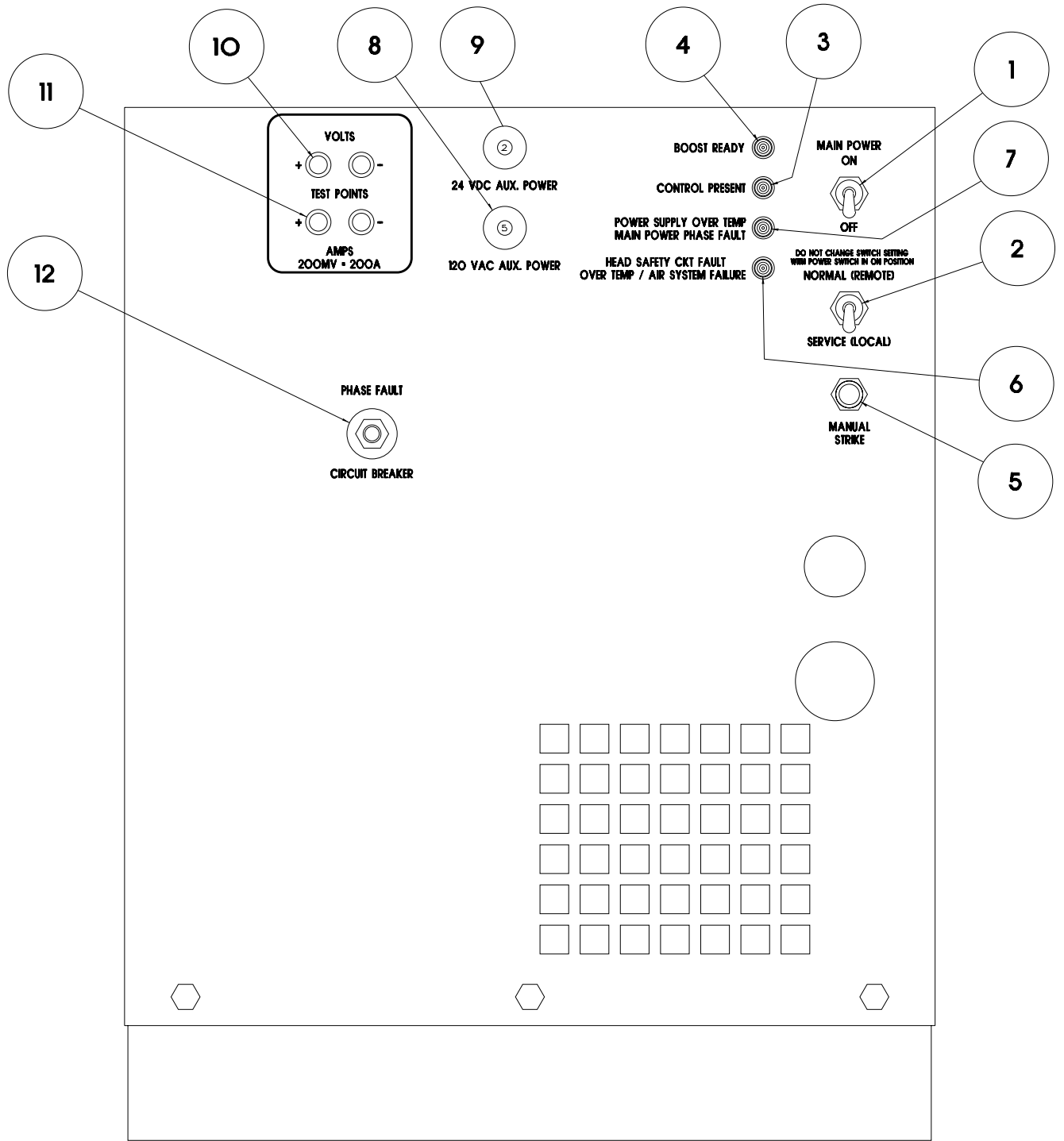

FIG-5 CONTROL PANEL

BL4000AR CONTROL PANEL & SYSTEM OPERATION

1. MAIN POWER SWITCH

USED TO MANUALLY CONTROL THE SYSTEM OPERATION. WHEN THE NORMAL (REMOTE) / SERVICE (LOCAL) SELECTOR SWITCH IS IN THE NORMAL POSITION THE MAIN POWER SWITCH WILL PREVENT THE SYSTEM FROM ENERGIZING WHEN THE CONTROL POWER CIRCUIT TURNS ON. WHEN THE NORMAL (REMOTE)/ SERVICE (LOCAL) SELECTOR SWITCH IS IN THE SERVICE POSITION THE MAIN POWER SWITCH ACTS AS A NORMAL POWER SWITCH TURNING THE SYSTEM BOTH ON AND OFF.

2. NORMAL (REMOTE) / SERVICE (LOCAL) SELECTOR SWITCH

USED TO SELECT THE MODE OF OPERATION FOR THE SYSTEM. WHEN THIS SWITCH IS IN THE NORMAL (REMOTE) POSITION THE SYSTEM IS ENERGIZED AND DE-ENERGIZED BY THE REMOTE CONTROL CIRCUIT. WHEN THIS SWITCH IS IN THE SERVICE (LOCAL) POSITION THE SYSTEM GENERATES IT'S CONTROL POWER INTERNALLY FROM THE 120 VOLT MAIN SERVICE SO THE SYSTEM CAN BE OPERATED AS AN INDEPENDENT UNIT WITHOUT THE REMOTE CONTROL CIRCUIT ENERGIZED.

3. CONTROL READY INDICATOR

MONITORS THE VOLTAGE ON THE CIRCUIT THAT CONTROLS THE OPERATION OF THE SYSTEM. THIS INDICATOR WILL LIGHT WHENEVER CONTROL POWER IS AVAILABLE AT THE LINE SIDE OF THE MAIN POWER SWITCH. THIS CONDITION WILL EXIST WHEN THE SYSTEM IS IN THE NORMAL OPERATING MODE AND THE REMOTE CONTROL SWITCH CIRCUIT IS CLOSED AND WHEN THE SYSTEM IS OPERATING IN THE SERVICE MODE.

4. BOOST READY INDICATOR

MONITORS THE OUTPUT OF THE BALLAST AND LIGHTS WHENEVER THE OUTPUT VOLTAGE IS OVER 100 VDC. WHEN THIS INDICATOR LIGHTS THE OUTPUT OF THE BALLAST IS AT A VOLTAGE SUFFICIENT TO IGNITE THE LAMP. UNDER NORMAL OPERATING CONDITIONS THIS INDICATOR WILL LIGHT FOR A MOMENT JUST BEFORE THE AUTO STRIKE CIRCUIT IGNITES THE LAMP. IF THE SYSTEM DOES NOT AUTO STRIKE AND THIS LAMP IS LIT CHECK THE AUTO STRIKE AND IGNITOR CIRCUITS. IF THE SYSTEM DOES NOT AUTO STRIKE AND THIS LAMP IS NOT LIT CHECK THE BALLAST CORE.

5. MANUAL STRIKE SWITCH

THIS SWITCH IS NOT NORMALLY USED. IT HAS BEEN INSTALLED AS A TROUBLE SHOOTING AID. THIS SWITCH IS WIRED IN PARALLEL WITH THE AUTO STRIKE RELAY CIRCUIT. IF THE SYSTEM DOES NOT STRIKE AUTOMATICALLY THIS SWITCH WILL ENERGIZE THE IGNITOR CIRCUIT IN THE LAMP HEAD. IF THE IGNITOR IN THE HEAD FIRES WHEN THIS SWITCH IS DEPRESSED THE IGNITOR CIRCUIT IN THE HEAD IS IN OPERATING ORDER. IF THE IGNITOR WORKS AND THE LAMP LIGHTS THEN THE AUTO STRIKE CIRCUIT SHOULD BE CHECKED. IF THE LAMP DOES NOT LIGHT WHEN THE IGNITOR FIRES THEN THE TROUBLE MAY BE IN THE POWER SUPPLY OR LAMP HEAD.

6. HEAD SAFETY CIRCUIT FAULT INDICATOR.

THIS INDICATOR LIGHTS INDICATING A TROUBLE CONDITION IN THE LAMP HEAD. UNDER NORMAL OPERATING CONDITIONS THIS INDICATOR WILL LIGHT FOR A FEW SECONDS WHEN THE SYSTEM IS FIRST ENERGIZED UNTIL PRESSURE BUILDS UP IN THE LAMP HEAD COOLING SYSTEM. THIS INDICATOR WILL LIGHT IF THE FOLLOWING FAULT CONDITIONS EXIST IN THE LAMP HEAD SECTION OF THE SYSTEM. OVER TEMPERATURE, COOLING BLOWER FAILURE, INSUFFICIENT AIRFLOW WITHIN THE COOLING SYSTEM. WHEN THE PROBLEM IS CORRECTED THIS INDICATOR WILL EXTINGUISH AND THE SYSTEM WILL GO INTO NORMAL OPERATION.

7. POWER SUPPLY OVER TEMP / MAIN POWER PHASE FAULT INDICATOR.

THIS INDICATOR WILL LIGHT IF THE FOLLOWING CONDITIONS EXIST IN THE BALLAST SECTION OF THE SYSTEM. IF THE POWER SUPPLY FAULT INDICATOR IS LIT THE BALLAST CORE IS OVER SAFE OPERATING TEMPERATURE OR THE PHASE LOSS CIRCUIT BREAKER (CB1 LOCATED ON THE FRONT OF THE BALLAST CORE AT THE TOP LEFT OF THE INPUT CONTACTOR) HAS TRIPPED. CHECK THE HEAT SINK AND EXHAUST COOLING FAN OPERATION. IF THE PHASE LOSS CIRCUIT BREAKER IS TRIPPED CHECK THE INPUT POWER FOR A MISSING PHASE OR LINE IMBALANCE AND RESET THE CIRCUIT BREAKER. WHEN THE PROBLEM IS CORRECTED THIS INDICATOR WILL EXTINGUISH AND THE SYSTEM WILL GO INTO NORMAL OPERATION.

NOTE

IF A FAULT CONDITION EXISTS IN BOTH THE LAMP HEAD AND BALLAST UNITS (SUCH AS A TRIPPED PHASE LOSS CIRCUIT BREAKER AND A NON OPERATING LAMP HEAD COOLING SYSTEM) BOTH INDICATOR WILL LIGHT DIMLY.

8. 120 VAC INPUT POWER CIRCUIT BREAKER.

THIS CIRCUIT BREAKER PROTECTS THE 120VAC AUXILIARY POWER CIRCUIT FROM OVERLOADS AND SHORT CIRCUITS.

9. SCROLLER/SHUTTER 24VDC POWER SUPPLY INPUT POWER CIRCUIT BREAKER.

PROTECTS THE SCROLLER/SHUTTER POWER SUPPLY INPUT WIRING FROM OVER CURRENT, AND SHORT CIRCUIT CONDITIONS.

10. BALLAST VOLTAGE OUTPUT TEST POINTS

USED TO MONITOR THE BALLAST OUTPUT VOLTAGE DURING THE POWER OUTPUT ADJUSTMENT PROCEDURE. OUTPUT RANGE 0 - 140 VDC.

11. BALLAST CURRENT OUTPUT TEST POINTS

USED TO MONITOR THE BALLAST OUTPUT CURRENT DURING THE POWER OUTPUT ADJUSTMENT PROCEDURE. OUTPUT RANGE 0 - 200 MILLIVOLTS DC = (0 - 200 AMPS DC).

12. PHASE FAULT CIRCUIT INTERRUPTER CB1

IF THE 208 VOLT MAIN POWER SERVICE LOSES A PHASE WHILE THE SYSTEM IS RUNNING OR A COMPONENT IN THE POWER SUPPLY FAILS CAUSING EXCESSIVE OUTPUT RIPPLE THIS DEVICE WILL TRIP DISABLING THE SYSTEM OPERATION. THIS DEVICE WILL NOT SELF RESET. IT WILL BE NECESSARY TO LOCATE THE CAUSE OF THE TROUBLE CORRECT THE PROBLEM AND THEN RESET CB1 LOCATED ON THE LEFT SIDE OF THE BALLAST.

LAMP OPERATION

REMOTE OPERATION

1. SET THE LAMP CONTROL SWITCH (2) TO THE NORMAL (REMOTE) POSITION.
2. SET THE MAIN POWER SWITCH (1) TO THE ON POSITION.
3. WHEN THE SYSTEM REMOTE CONTROL CIRCUIT IS CLOSED THE LAMP WILL AUTOMATICALLY STRIKE AND WILL REMAIN LIT UNTIL THE CONTROL CIRCUIT IS OPENED OR THE LAMP POWER SWITCH IS SET TO THE OFF POSITION.

LOCAL OPERATION

1. SET THE LAMP CONTROL SWITCH (2) TO THE SERVICE (LOCAL) POSITION.
2. SET THE LAMP POWER SWITCH (1) TO THE ON POSITION.
3. THE LAMP WILL AUTOMATICALLY STRIKE AND WILL REMAIN LIT UNTIL THE LAMP POWER SWITCH IS SET TO THE OFF POSITION.

NOTE

THE LAMP HEAD AND BALLAST COOLING SYSTEMS ARE ON A 30 MINUTE TIME DELAY TO ALLOW PROPER COOLING AFTER THE LAMP IS TURNED OFF.

HEAD FAULT INDICATOR

IF THE HEAD FAULT INDICATOR (6) IS LIT THE LAMP HEAD IS OVER SAFE OPERATING TEMPERATURE OR THE COOLING BLOWER HAS FAILED.

POWER SUPPLY FAULT INDICATOR

IF THE POWER SUPPLY FAULT INDICATOR (7) IS LIT THE POWER SUPPLY IS OVER SAFE OPERATING TEMPERATURE OR THE PHASE LOSS CIRCUIT BREAKER (12) (LOCATED ON THE LEFT SIDE OF THE BALLAST) HAS TRIPPED. CHECK THE BASE COOLING FAN OPERATION (BL1). IF THE PHASE LOSS CIRCUIT BREAKER (12) IS TRIPPED CHECK THE INPUT POWER FOR A MISSING PHASE OR LINE IMBALANCE AND RESET THE CIRCUIT BREAKER.

SYSTEM ADJUSTMENTS

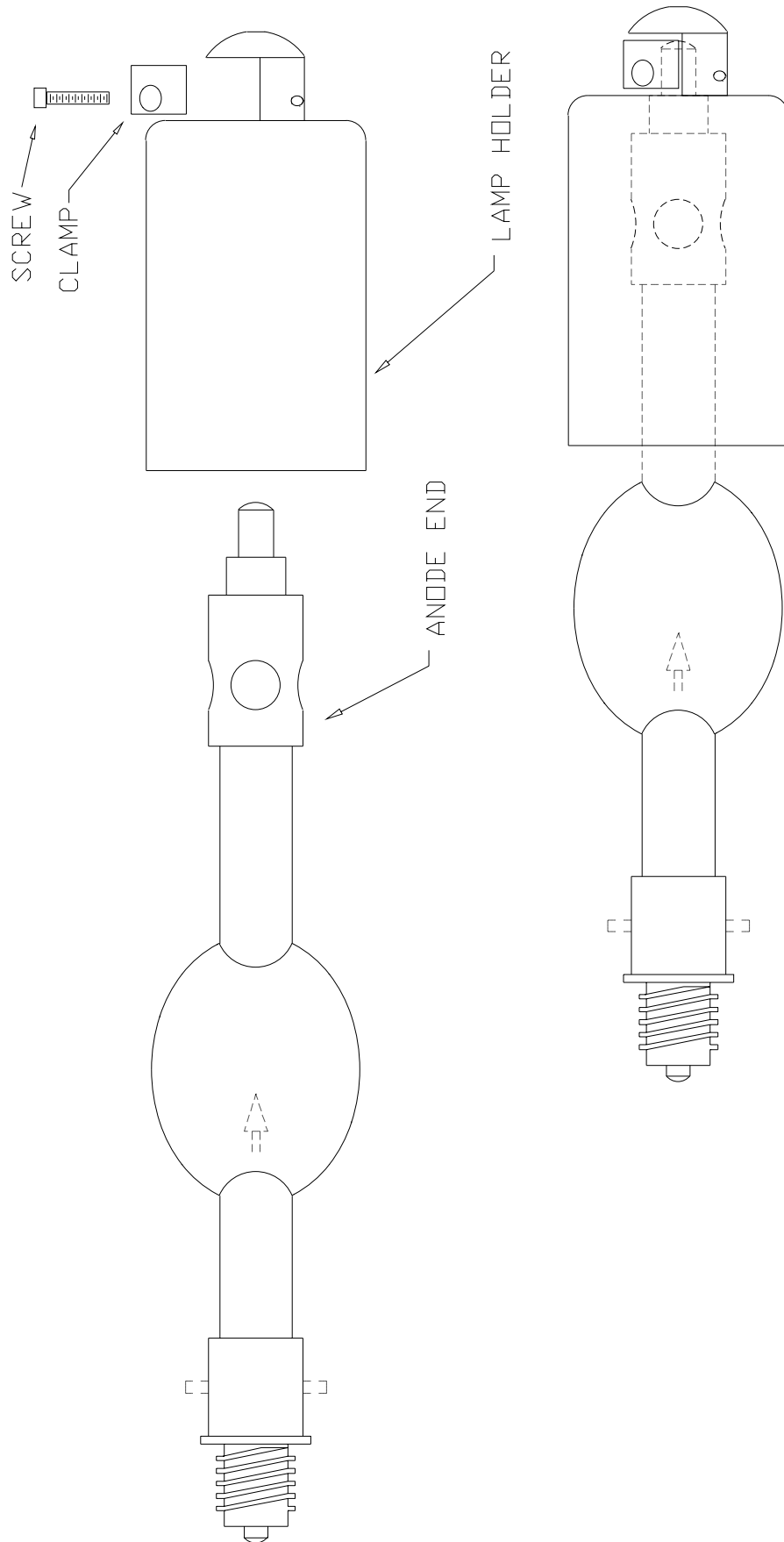

FIG-6 FRONT LAMP HOLDER ASSEMBLY

INSTRUCTIONS FOR REMOVING AND INSTALLING A TYPE TH LAMP IN A BL4000AR FIXTURE

NOTE

FAMILIARIZE YOURSELF WITH THE LOCATION AND IDENTIFICATION OF THE COMPONENTS OF THIS SYSTEM AND ALSO THE NORMAL OPERATION OF THE SYSTEM BEFORE ATTEMPTING ANY ADJUSTMENT OR SERVICE.

NOTE

COMPLETELY READ THROUGH AND HAVE A GOOD UNDERSTANDING OF THE PROCEDURES BEFORE ATTEMPTING TO SERVICE THIS SYSTEM. FAILURE TO DO SO MAY RESULT IN FATAL INJURY OR EQUIPMENT DAMAGE.

NOTE

THE LAMP HEAD SHOULD BE IN THE HORIZONTAL POSITION DURING THE GLOBING PROCEDURES.

WARNING

DISCONNECT POWER SOURCE BEFORE SERVICING THIS EQUIPMENT.

WARNING

THIS SYSTEM MAY BE UNDER THE CONTROL OF AN AUTOMATIC TIMING SYSTEM AND MAY START AT ANY TIME WHEN THE LOCAL/REMOTE SELECTOR SWITCH IS IN THE REMOTE POSITION.

WARNING

A PROTECTIVE JACKET, FULL FACE SHIELD, AND PROTECTIVE GLOVES MUST BE WORN AT ALL TIMES WHEN THE LAMP HEAD IS OPENED WITH A LAMP INSTALLED OR WHEN HANDLING THE XENON LAMPS. SERIOUS INJURY MAY OCCUR IF PROPER SAFETY PRECAUTIONS ARE NOT OBSERVED. READ ALL ENCLOSED INSTRUCTIONS AND INFORMATION SHEETS BEFORE HANDLING THE LAMP.

WARNING

NEVER OPERATE A FIXTURE WITH AN EXPOSED LAMP! THERE IS AN EXTREME DANGER OF SEVERE BURNS TO EXPOSED SKIN AND EYES FROM THE ULTRAVIOLET LIGHT EMITTED FROM THE EXPOSED LAMP. DAMAGE CAN OCCUR IN AS LITTLE AS 30 SECONDS OF EXPOSURE. THERE IS ALSO AN ADDITIONAL DANGER FROM FLYING GLASS IF AN EXPOSED LAMP EXPLODES!

EQUIPMENT REQUIRED

1. PROTECTIVE SAFETY EQUIPMENT KIT
2. 7/16" WRENCH OR SOCKET
3. ALLEN WRENCH 5/32"
4. PHILLIPS SCREWDRIVER #2

DISASSEMBLY PROCEDURE

IF THERE IS NO LAMP INSTALLED IN THE FIXTURE

1. RELEASE THE 4 1/4 TURN FASTENERS LOCATED AT THE SMALL SIDES OF THE COWL USING A #2 PHILLIPS SCREWDRIVER AND REMOVE THE COWLING.
2. REMOVE THE 2 BRASS BOLTS CONNECTING THE SHORT LEADS TO THE FRONT LAMP HOLDER USING A 7/16" WRENCH..
3. REMOVE THE CENTER MOUNTING SCREW WASHER AND SPRING FROM THE SPIDER USING A 5/32" ALLEN WRENCH WHILE SUPPORTING THE FRONT LAMP HOLDER SO THAT IT DOES NOT FALL WHEN THE SCREW IS REMOVED.
4. REMOVE THE LAMP HOLDER FROM THE FIXTURE.
5. TO DISASSEMBLE THE FRONT LAMP HOLDER REMOVE THE 2 CLAMP RETAINING SCREWS LOCATED ON THE SIDE OF THE LAMP SWIVEL HUB USING A 5/32" ALLEN WRENCH AND REMOVE THE CLAMP.

DISASSEMBLY PROCEDURE

IF THERE IS A LAMP IS INSTALLED IN THE FIXTURE

1. RELEASE THE (4) 1/4 TURN FASTENERS LOCATED AT THE SMALL SIDES OF THE COWL USING A #2 PHILLIPS SCREWDRIVER AND REMOVE THE COWLING.

CAUTION

DO NOT PLACE ANY EXCESSIVE FORCE ON THE LAMP WHILE REPLACING THE PROTECTIVE WRAPPER!

2. WRAP THE LAMP SECURELY IN THE PROTECTIVE WRAPPER THAT THE LAMP WAS ORIGINALLY SHIPPED WITH.
3. REMOVE THE 2 BRASS BOLTS CONNECTING THE SHORT LEADS TO THE FRONT LAMP HOLDER USING A 7/16" WRENCH.

NOTE

IT MAY BE NECESSARY TO ADJUST THE FOCUS TO ITS FULL FRONTAL POSITION TO REMOVE THE LAMP.

4. REMOVE THE CENTER MOUNTING SCREW WASHER AND SPRING FROM THE SPIDER USING A 5/32" ALLEN WRENCH WHILE SUPPORTING THE FRONT LAMP HOLDER SO THAT THE LAMP DOES NOT DROP WHEN THE MOUNTING SCREW IS REMOVED.

WARNING

DO NOT EXSERT EXCESSIVE FORCE ON THE LAMP WHILE UNSCREWING IT FROM THE REAR LAMP HOLDER! THE LAMP SHOULD RELEASE FROM THE REAR LAMP HOLDER WITH A VERY LIGHT COUNTER CLOCKWISE ROTATION IF THIS DOES NOT HAPPEN SEE THE PROCEDURE FOR REMOVING A FROZEN LAMP.

5. REMOVE THE LAMP BY LIGHTLY PUSHING BACK ON THE LAMP TO MOVE THE REAR LAMP HOLDER TO IT'S REAR MOST POSITION WHILE LIGHTLY TURNING THE LAMP IN A COUNTERCLOCKWISE ROTATION. THE LAMP WILL RELEASE FROM THE REAR LAMP HOLDER IN APPROXIMATELY 1.5 COMPLETE TURNS.
6. REMOVE THE LAMP WITH THE FRONT LAMP HOLDER ATTACHED FROM THE FIXTURE AND PLACE IT ON A STABLE WORKING SURFACE FOR THE REMOVAL OF THE FRONT LAMP HOLDER.
7. TO REMOVE THE FRONT LAMP HOLDER FROM THE LAMP REMOVE THE 2 CLAMP RETAINING SCREWS LOCATED ON THE SIDE OF THE LAMP SWIVEL HUB USING A 5/32" ALLEN WRENCH AND REMOVE THE CLAMP.
9. REMOVE THE LAMP HOLDER FROM THE LAMP AND PLACE THE LAMP INTO ITS SHIPPING CONTAINER FOR SAFE KEEPING. RESECURE THE PROTECTIVE WRAPPER IF NECESSARY.

REMOVING A FROZEN LAMP

1. REPLACE THE FRONT LAMP HOLDER RETAINING BOLT TO SUPPORT THE FRONT OF THE LAMP WHILE FREEING THE LAMP FROM THE REAR LAMP HOLDER.

WARNING

DO EXERT ANY FORCE ON THE GLASS PORTIONS OF THE LAMP WHILE ATTEMPTING TO FREE IT FROM THE REAR LAMP HOLDER!

2. REACH THROUGH THE OPENING IN THE REAR OF THE REFLECTOR AND GRASP THE LAMP BY ITS REAR FERRULE AND WHILE LIGHTLY PUSHING THE LAMP BACK INTO THE RECEIVER BLOCK TURN THE LAMP IN A COUNTERCLOCKWISE DIRECTION UNTIL THE LAMP BEGINS TO ROTATE FREELY.
3. ONCE THE LAMP IS FREE DO NOT REMOVE IT COMPLETELY FROM THE REAR LAMP HOLDER.
4. RETURN TO STEP 5 OF :

**“DISASSEMBLY PROCEDURE
IF THERE IS A LAMP IS INSTALLED IN THE FIXTURE”**

ASSEMBLY PROCEDURE

WARNING

DO NOT REMOVE THE PROTECTIVE COVER FROM THE LAMP UNTIL INSTRUCTED TO DO SO!

WARNING

DO EXERT ANY FORCE ON THE GLASS PORTIONS OF THE LAMP AT ANY TIME!

NOTE

IF THE FRONT LAMP HOLDER HAS NOT BEEN DISASSEMBLED SEE THE LAST STEPS IN THE APPROPRIATE DISASSEMBLY INSTRUCTIONS.

1. UNTIE THE CORD ON THE ANODE END OF THE PROTECTIVE COVER. DO NOT REMOVE THE COVER AT THIS TIME!
2. FASTEN FRONT LAMP HOLDER TO THE LAMP BY PLACING THE ANODE END (LARGE ELECTRODE) OF THE LAMP IN THE LAMP HOLDER AND ALIGNING THE STUD ON THE END OF THE LAMP FERRULE WITH THE CHANNEL IN THE NOSE OF THE LAMP HOLDER BODY. SLIDE THE LAMP COMPLETELY DOWN THE CHANNEL AS FAR AS IT WILL GO.

WARNING

DO NOT PLACE ANY PRESSURE ON THE LAMP WHILE REASSEMBLING THE FRONT LAMP HOLDER!

3. REPLACE THE CLAMP AND REINSTALL THE 2 CLAMP RETAINING SCREWS LOCATED ON THE SIDE OF THE LAMP SWIVEL HUB USING A 5/32 ALLEN WRENCH.
5. INSTALL THE LAMP INTO THE FIXTURE BY INSERTING THE CATHODE END OF THE LAMP THROUGH THE OPENING IN THE REFLECTOR.
6. INSERT THE END OF THE LAMP FERRULE INTO THE OPENING IN THE REAR LAMP HOLDER RECEIVER BLOCK AND ALIGN THE THREADS BY TURNING THE LAMP COUNTERCLOCKWISE UNTIL THE LAMP THREADS DROP INTO THE RECEIVER THREADS.

CAUTION

DO NOT OVER TIGHTEN THE LAMP IN THE RECEIVER BLOCK AS THIS MAY CAUSE THE LAMP TO FREEZE IN THE RECEIVER BLOCK MAKING IT DIFFICULT TO REMOVE. TIGHTEN THE LAMP JUST ENOUGH TO APPLY SPRING PRESSURE TO THE THREADS BUT NOT SO MUCH AS TO BOTTOM OUT THE LAMP FERRULE COMPLETELY AGAINST THE RECEIVER BLOCK.

7. GENTLY ROTATE THE LAMP CLOCKWISE UNTIL RESISTANCE IS FELT.
8. AT THIS POINT THE LAMP SHOULD BE IN CONTACT WITH THE SPRING PLUNGER ASSEMBLIES. GENTLY TURN THE LAMP AN ADDITIONAL 1/16-1/8 OF A TURN TO LOAD THE THREADS WITH THE SPRING PLUNGERS.
9. SECURE THE FRONT LAMP HOLDER TO THE SPIDER WITH THE SHOULDER BOLT, SPRING, AND WASHER THAT WAS REMOVED DURING DISASSEMBLY.
10. CONNECT THE 2 SHORT LEADS FROM THE SPIDER TO THE FRONT LAMP HOLDER USING THE 2 BRASS BOLTS AND WASHERS THAT WERE REMOVED DURING DISASSEMBLY.

NOTE

ANY TYPE OF ALCOHOL IS SUITABLE FOR CLEANING THE LAMP EXCEPT FOR ALCOHOL THAT HAS BEEN DENATURED USING PETROLEUM PRODUCTS SINCE THE DENATURING AGENT WILL LEAVE A RESIDUE ON THE LAMP.

11. REMOVE THE PROTECTIVE COVER FROM THE LAMP AND CLEAN THE GLASS PORTION OF THE LAMP COMPLETELY WITH ALCOHOL.
12. THE INSTALLATION IS NOW COMPLETE. REPLACE THE FRONT COWL AND TEST THE LAMP.
13. LOG THE HOUR METER READING AT INSTALLATION.
14. PERFORM THE OUTPUT POWER ADJUSTMENT PROCEDURES.
15. PREFORM THE FOCUS AND X-Y PROCEDURES.

FOCUS AND X-Y ADJUSTMENT INSTRUCTIONS

NOTE

FAMILIARIZE YOURSELF WITH THE LOCATION AND IDENTIFICATION OF THE COMPONENTS OF THIS SYSTEM AND ALSO THE NORMAL OPERATION OF THE SYSTEM BEFORE ATTEMPTING ANY ADJUSTMENT OR SERVICE.

NOTE

COMPLETELY READ THROUGH AND HAVE A GOOD UNDERSTANDING OF THE PROCEDURES BEFORE ATTEMPTING TO SERVICE THIS SYSTEM. FAILURE TO DO SO MAY RESULT IN FATAL INJURY OR EQUIPMENT DAMAGE.

EQUIPMENT REQUIRED

1. ALLEN WRENCH 5/32
2. # 5 WELDERS GLASSES OR VERY DARK SUNGLASSES

WARNING

THE BL4000 SYSTEMS PROJECT A VERY INTENSE BEAM OF FULL SPECTRUM LIGHT. THE USE OF DARK GLASSES WHILE ADJUSTING THE BEAM PARAMETERS ON A LIGHT COLORED REFLECTIVE SURFACE AT A CLOSE DISTANCE IS REQUIRED.

WARNING

NEVER LOOK DIRECTLY INTO A LIT FIXTURE'S LIGHT SOURCE.

ADJUSTMENT INSTRUCTIONS

1. LOOSEN THE POSITIONING FASTENERS AND POINT THE LAMP HEAD TOWARD A WALL, CEILING, OR OTHER FLAT SURFACE AT LEAST 10 FEET AWAY.
2. LOCATE THE FOCUS ADJUSTMENT ACCESS HOLE LOCATED ON THE REAR OF THE LAMP HEAD.
3. LOCATE THE X & Y ADJUSTMENT HOLES LOCATED ON THE LOWER SMALL SIDES OF THE FRONT COWL.

WARNING

THE BL4000 SYSTEMS PROJECT A VERY INTENSE BEAM OF FULL SPECTRUM LIGHT. CAUTION MUST BE TAKEN WHEN POINTING THE BEAM AT AN OBJECT AT A DISTANCE OF LESS THAN 100 FEET WITH THE FOCUS SET FOR A CONVERGING BEAM. COMBUSTIBLE OBJECTS AND OBJECTS WITH A DARK COLOR MAY UNEXPECTEDLY IGNITE IF CARE IS NOT TAKEN IN THE FOCUSING AND POSITIONING OF THE BEAM.

4. ENERGIZE THE FIXTURE AND IGNITE THE LAMP.
5. FLOOD OUT THE LIGHT BY ADJUSTING THE FOCUS ADJUSTMENT SCREW IN A CLOCKWISE DIRECTION USING A 5/32 ALLEN WRENCH TO PRODUCE A DIVERGING BEAM PATTERN WITH 2-3 CLEARLY DEFINED RINGS OF LIGHT WITH OR WITHOUT AN OFF CENTER HOT SPOT.
6. ADJUST THE X & Y ADJUSTMENT SCREWS USING A 5/32" ALLEN WRENCH TO MOVE THE INNER RINGS OF LIGHT TO CREATE CONCENTRIC RINGS WITH THE HOT SPOT AT THE CENTER OF THE LIGHT FIELD. TURNING THE ADJUSTMENT SCREW CLOCKWISE WILL MOVE THE RINGS TOWARD THAT ADJUSTMENT AXIS AND TURNING THE SCREW COUNTERCLOCKWISE WILL MOVE THE RINGS AWAY FROM THAT ADJUSTMENT AXIS.
7. READJUST THE FOCUS SCREW TO SET THE DESIRED BEAM SPREAD.
8. REPOSITION THE LAMP HEAD AND RESECURE THE POSITION LOCKING FASTENERS.

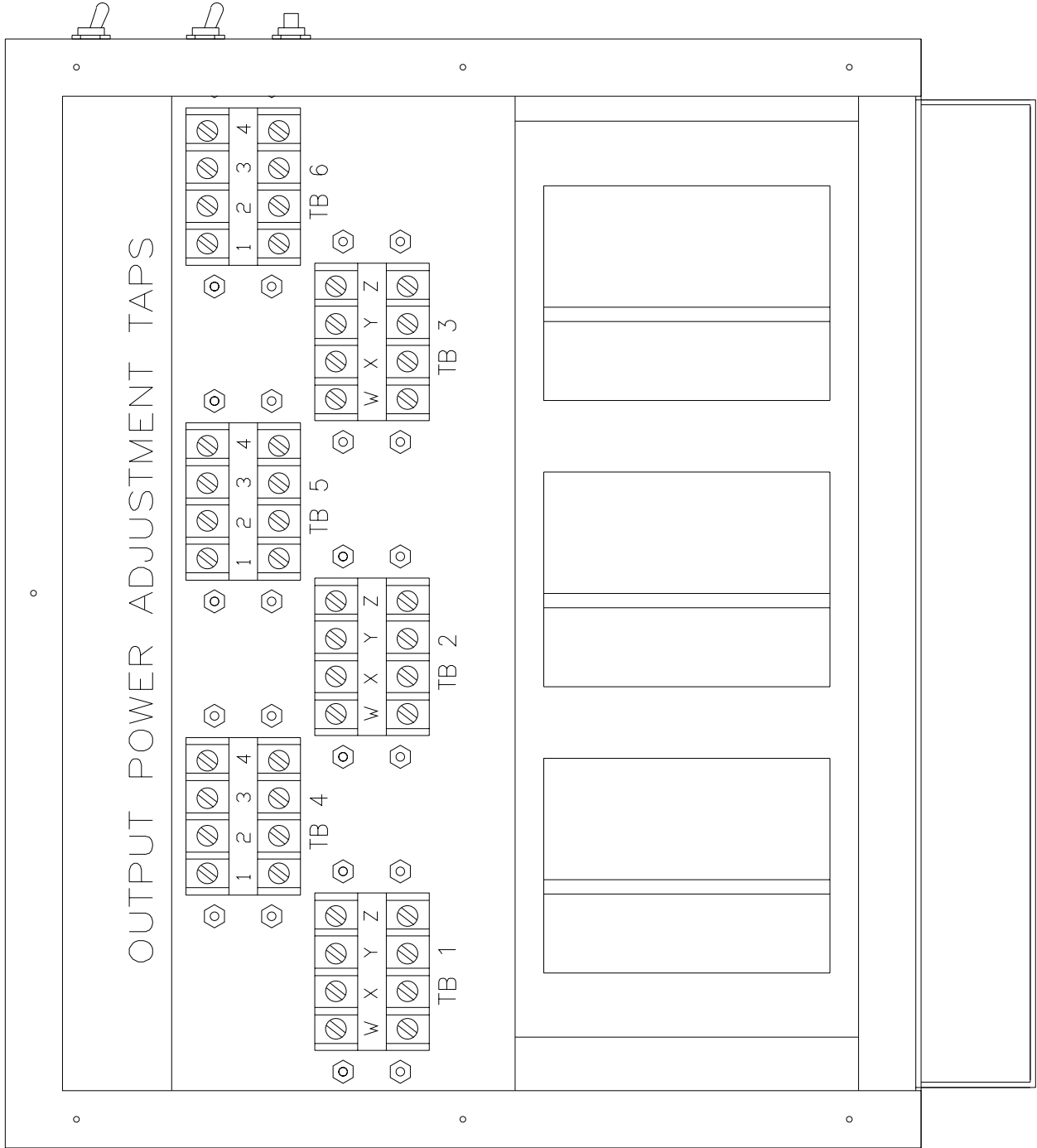

FIG-7 BALLAST REAR VIEW

OUTPUT POWER ADJUSTMENT PROCEDURES

NOTE

FAMILIARIZE YOURSELF WITH THE LOCATION AND IDENTIFICATION OF THE COMPONENTS OF THIS SYSTEM AND ALSO THE NORMAL OPERATION OF THE SYSTEM BEFORE ATTEMPTING ANY ADJUSTMENT OR SERVICE.

NOTE

COMPLETELY READ THROUGH AND HAVE A GOOD UNDERSTANDING OF THE PROCEDURES BEFORE ATTEMPTING TO SERVICE THIS SYSTEM. FAILURE TO DO SO MAY RESULT IN FATAL INJURY OR EQUIPMENT DAMAGE.

NOTE

THE LAMP HEAD SHOULD BE IN THE VERTICAL POSITION DURING THE POWER ADJUSTMENT PROCEDURE.

WARNING

DISCONNECT POWER SOURCE BEFORE SERVICING THIS EQUIPMENT.

WARNING

THIS SYSTEM MAY BE UNDER THE CONTROL OF AN AUTOMATIC TIMING SYSTEM AND MAY START AT ANY TIME WHEN THE LOCAL / REMOTE SELECTOR SWITCH IS IN THE REMOTE POSITION.

EQUIPMENT REQUIRED

1. SCREWDRIVER FLAT BLADE, LARGE
2. WRENCH 3/8"
3. DC VOLTMETER WITH A RANGE OF 50 VOLTS
4. DC VOLT METER WITH A RANGE OF 200 MILLIAMPS.

ADJUSTMENT INSTRUCTIONS

1. REMOVE THE FRONT AND REAR ACCESS COVERS FROM THE BALLAST ENCLOSURE BY REMOVING THE SIX SCREWS ALONG THE SIDES OF THE PANELS WITH A 3/8 WRENCH.
2. NOTE THE LOCATION AND SETTINGS OF THE BALLAST CORE ADJUSTMENT TAPS (LOCATED ON THE UPPER REAR PORTION OF THE BALLAST CORE).
3. IF THE SYSTEM IS TO BE ADJUSTED WITHOUT THE CONTROL TIMING CIRCUIT ENERGIZED SET THE MAIN POWER SWITCH TO THE OFF POSITION AND SET THE LOCAL / REMOTE SELECTOR SWITCH TO THE LOCAL POSITION.
4. SET THE MAIN POWER SWITCH TO THE ON POSITION. THE UNIT COOLING SYSTEM SHOULD START IMMEDIATELY, AND THE LAMP SHOULD STRIKE AFTER A SEVERAL SECOND DELAY. IF NOTHING HAPPENS AND THE SELECTOR SWITCH IS SET PER STEP 3 (LOCAL OPERATION) CHECK THE CONTROL PRESENT INDICATOR. IF THE INDICATOR IS NOT LIT CHECK THE MAIN 3 PHASE POWER SUPPLYING THIS SYSTEM IN ALL LIKELIHOOD THE MAIN POWER HAS BEEN TURNED OFF AT THE SOURCE.
5. ONCE THE UNIT IS OPERATING MEASURE THE OUTPUT VOLTAGE AND CURRENT AT THE TEST POINTS ON THE CONTROL PANEL. IF THE OUTPUT CURRENT IS OVER 135 AMPS IMMEDIATELY TURN OFF THE LIGHT AND GO TO STEP 8.
6. CALCULATE THE OUTPUT POWER USING THE FORMULA (VOLTS) X (AMPS) = (WATTS). IF THE POWER LEVEL IS OVER 4200 WATTS IMMEDIATELY TURN OFF THE LIGHT AND GO TO STEP 8.
7. ALLOW THE LIGHT TO RUN AT LEAST 10 MINUTES BEFORE MAKING ANY ADJUSTMENTS.

8. TURN OFF THE LIGHT USING THE MAIN POWER SWITCH ON THE CONTROL PANEL. THE COOLING SYSTEM WILL CONTINUE TO RUN FOR AT LEAST 30 MINUTES AFTER THE POWER IS TURNED OFF. DO NOT BE CONCERNED. THE POWER TO THE POWER SUPPLY ADJUSTMENT TAPS HAS BEEN DISCONNECTED BY THE UNIT'S MAIN POWER CONTACTOR.

WARNING

ALL THREE TERMINAL BLOCKS IN THE COARSE AND FINE ADJUSTMENT GROUPS MUST BE SET AT THE SAME LETTER OR NUMBER TAP SETTING. FAILURE TO OBSERVE THE CORRECT TAP SETTINGS WILL RESULT IN SHORTENED LAMP LIFE, EXCESSIVE INPUT CURRENT DRAW, AND POSSIBLE EQUIPMENT DAMAGE.

9. ADJUST THE INPUT VOLTAGE TAPS (TB-1)-(TB-6) TO SET THE OUTPUT POWER LEVEL TO 4000 WATTS +/- 5%.
10. THE TAPS ON (TB-1-3) LABELED W,X,Y,Z ARE COARSE ADJUSTMENTS WITH TAP (W) BEING THE LOWEST CURRENT AND TAP (Z) BEING THE HIGHEST CURRENT.
11. THE TAPS ON (TB-4-6) LABELED 1,2,3,4 ARE FINE ADJUSTMENTS WITH TAP (1) BEING THE LOWEST CURRENT AND TAP (4) BEING THE HIGHEST CURRENT.
12. BE SURE ALL THE TERMINAL BLOCK SCREWS HAVE BEEN TIGHTENED THEN REENERGIZE THE UNIT USING THE MAIN POWER SWITCH.
13. REPEAT STEPS 5 THRU 12 UNTIL THE POWER SUPPLY HAS BEEN PROPERLY ADJUSTED. WHEN THE ADJUSTMENTS ARE COMPLETED REPLACE THE BALLAST ACCESS PANELS.

CIRCUIT DESCRIPTIONS

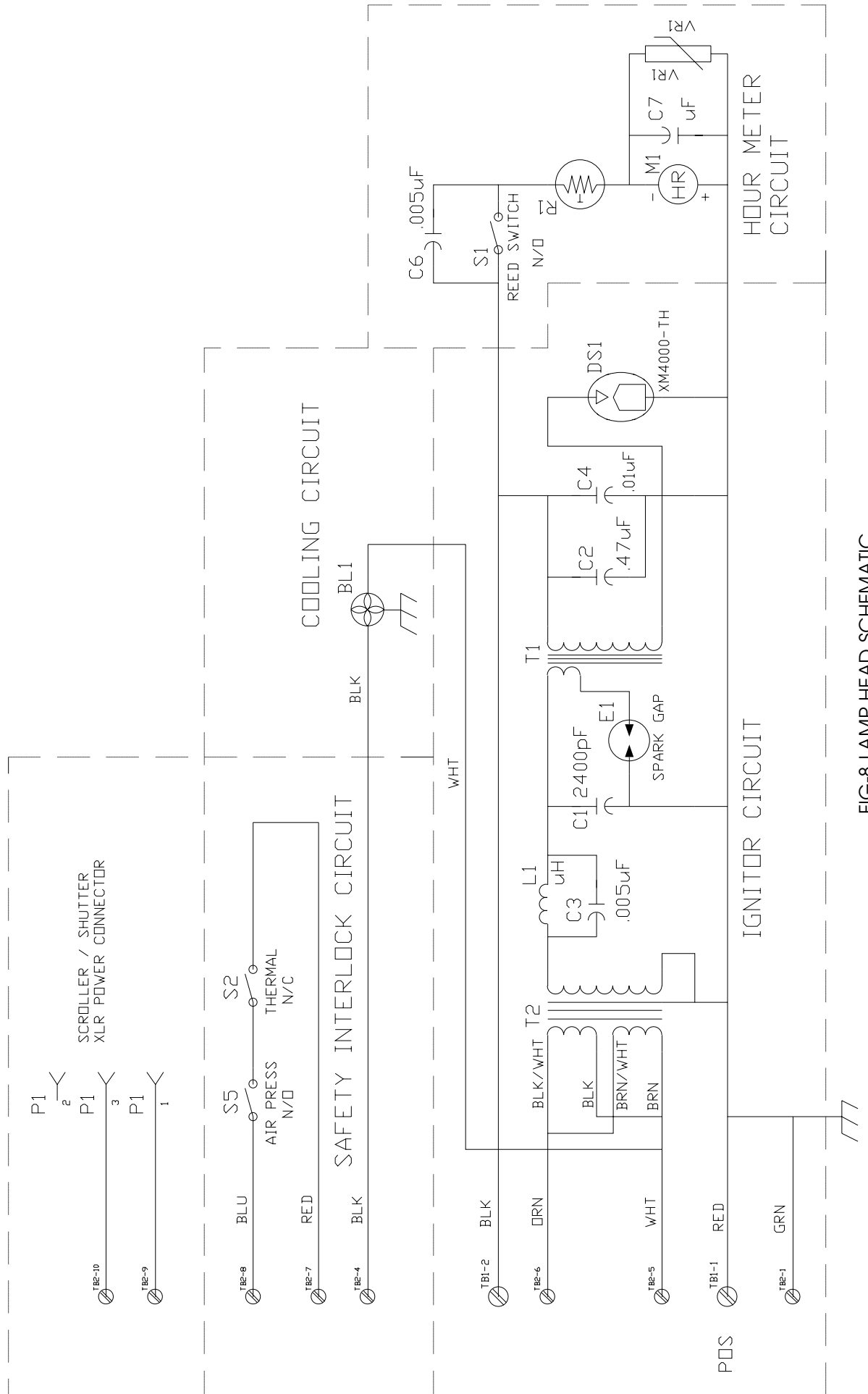

FIG-8 LAMP HEAD SCHEMATIC

IGNITOR CIRCUIT THEORY OF OPERATION

WHEN POWER IS APPLIED THROUGH THE ORANGE AND WHITE WIRES FROM PINS 1 AND 2 RESPECTIVELY OF (P2) TO THE INPUT STEP UP TRANSFORMER (T2) AT 115 VAC, 60 HZ, IT CAUSES THE SPARK GAP (E1) TO BREAK DOWN. THE RF TRAP (L1, C3) IN THE SECONDARY OF (T2) MINIMIZES RF LOSSES TO THE POWER LINE. THE SPARK GAP BREAKDOWN ALLOWS CURRENT TO FLOW IN THE RESONANT CIRCUIT CONSISTING OF (C1) AND THE PRIMARY OF (T1). A SERIES OF DAMPED OSCILLATIONS OCCUR (AT 2 TO 4 MHZ) DURING A PORTION OF EACH HALF OF THE 60 HZ LINE FREQUENCY. THESE HIGH FREQUENCY PULSES ARE STEPPED UP IN VOLTAGE (TO APPROXIMATELY 60 KV) THRU (T1) AND THEN APPLIED TO THE LAMP TERMINALS. (C2, C4) PROVIDES A LOW IMPEDANCE, RF RETURN PATH FOR THE HIGH VOLTAGE PULSE THOROUGH THE LAMP. AN ARC IS STRUCK IN THE LAMP IONIZING THE INSULATING XENON GAS AND WHEN SUITABLE DC POWER IS AVAILABLE THE LAMP WILL IGNITE.

SAFETY INTERLOCK CIRCUIT THEORY OF OPERATION

THE SAFETY INTERLOCK CIRCUIT IS COMPOSED OF A THERMAL SWITCH (S2) LOCATED ON THE LOWER RIGHT FRONT SPIDER ARM AND AN AIR PRESSURE SWITCH (S5) LOCATED AT THE REAR OF THE LAMP HEAD NEAR THE COOLING BLOWER.

IF THE LAMP HEAD BECOMES TOO HOT TO SAFELY OPERATE THE LAMP THE THERMAL SWITCH (S2) WILL OPEN CAUSING THE BALLAST CONTACTOR (K1) TO DE-ENERGIZE TURNING THE LAMP OFF. WHEN THE LAMP HEAD COOLS TO A SAFE OPERATING TEMPERATURE THE THERMAL SWITCH (S2) WILL RESET AND THE SYSTEM WILL AUTOMATICALLY RELIGHT.

IF THE LAMP HEAD COOLING SYSTEM BECOMES INOPERATIVE OR BECOMES BLOCKED WITH DEBRIS THE AIR PRESSURE SWITCH WILL DETECT THE DROP IN BLOWER INTAKE PRESSURE AND WILL OPEN CAUSING THE BALLAST CONTACTOR (K1) TO DE-ENERGIZE TURNING THE LAMP OFF. WHEN THE PROBLEM HAS BEEN CORRECTED AND THE COOLING SYSTEM IS OPERATING CORRECTLY THE AIR PRESSURE SWITCH WILL RESET AND THE SYSTEM WILL RELIGHT.

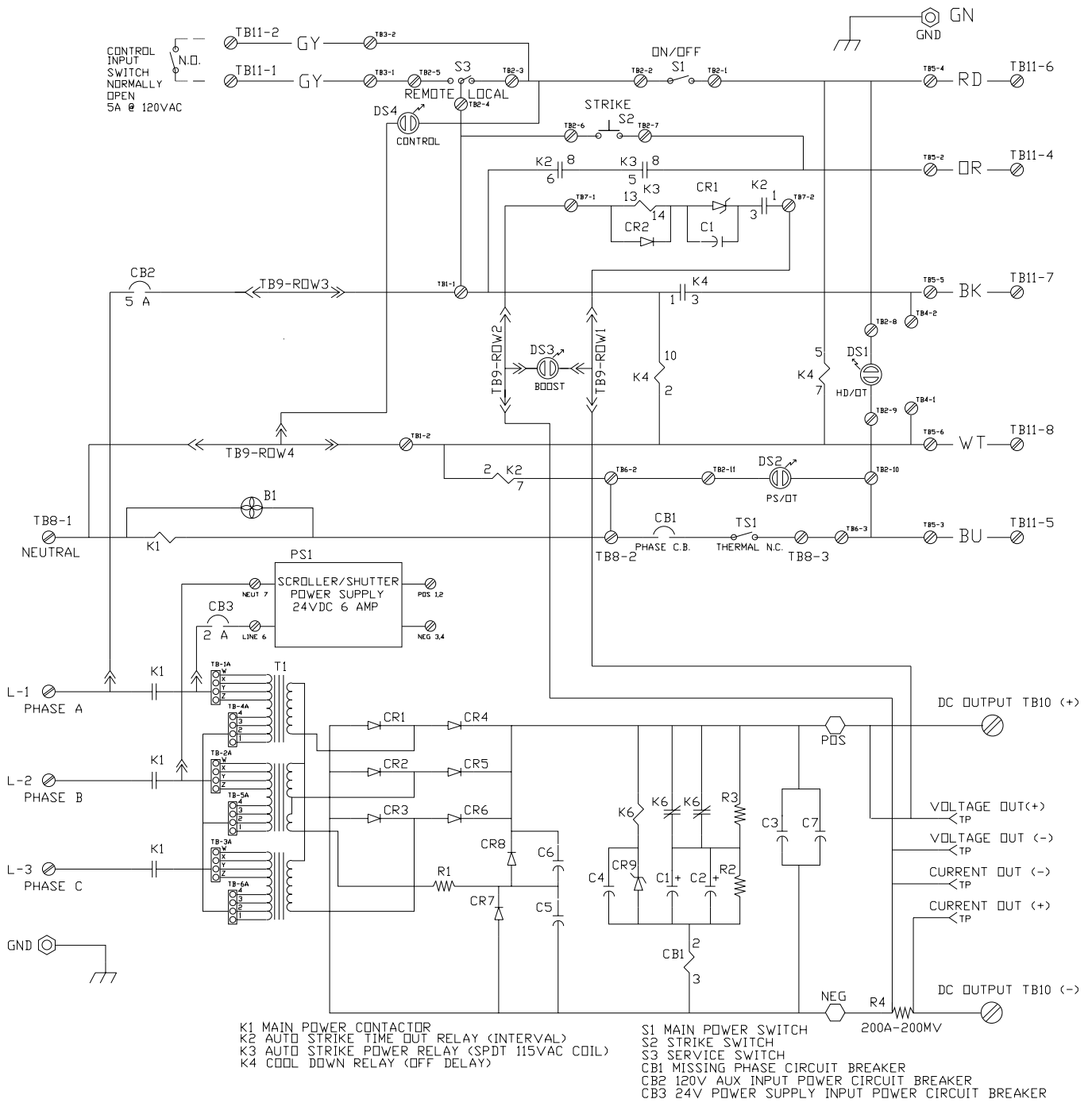

FIG-9 BALLAST SCHEMATIC

4 KW POWER SUPPLY THEORY OF OPERATION

THE XENON LAMP POWER SUPPLY HAS TWO STAGES OF OPERATION. BEFORE THE LAMP HAS LIT THE BOOST VOLTAGE CIRCUIT SUPPLIES 100 VDC OR MORE TO THE LAMP. THIS BOOSTED VOLTAGE ENHANCES THE INITIAL IGNITION ARC FOR SEVERAL HUNDRED MILLISECONDS AFTER THE LAMP HAS LIT ASSURING A RELIABLE IGNITION. UPON IGNITION OF THE LAMP THE MAIN POWER SUPPLY TAKES OVER SUPPLYING LOW VOLTAGE AND REGULATED CONSTANT HIGH CURRENT.

THE BOOST CIRCUIT FUNCTIONS AS FOLLOWS. THE POWER SUPPLY TRANSFORMER CONTAINS A SET OF HIGH VOLTAGE LOW CURRENT AUXILIARY WINDINGS. THESE WINDINGS SUPPLY A MINIMUM OF 85 VAC. THE VOLTAGE PASSES THROUGH THE CURRENT LIMITING RESISTOR (R1) AND IS FULL WAVE RECTIFIED BY DIODES (CR7,8,2,5). THE RECTIFIED VOLTAGE IS THEN STORED IN CAPACITORS (C1, C2) UNTIL THE IGNITOR CIRCUIT IS ENERGIZED.

THE MAIN POWER SUPPLY CIRCUIT FUNCTIONS AS FOLLOWS. THE MAIN THREE PHASE POWER ENTERS THE UNIT AT THE INPUT TERMINALS OF THE POWER CONTACTOR (K1). WHEN THE CONTACTOR IS ENERGIZED CURRENT FLOWS THROUGH THE POWER ADJUSTMENT TERMINAL BOARDS (TB1 - 6) TO THE PRIMARY WINDINGS OF THE POWER TRANSFORMER (T1). THE POWER TRANSFORMER STEPS DOWN THE INPUT VOLTAGE AND LIMITS THE OUTPUT CURRENT TO A RANGE THAT IS SAFE FOR THE OPERATION OF THE LAMP THAT IS ATTACHED TO THE POWER SUPPLY. THE POWER TRANSFORMER OUTPUT IS THEN RECTIFIED BY THE POWER DIODES (CR1-6) AND FILTERED BY THE OUTPUT CAPACITORS (C1-2). CAPACITOR (C3, C7) FORM A FILTER TO PROTECT THE POWER DIODES FROM HIGH VOLTAGE SPIKES ON THE OUTPUT POWER LINES WHEN THE IGNITOR IS ENERGIZED.

WHEN THE IGNITOR CIRCUIT IS ENERGIZED A HIGH VOLTAGE HIGH FREQUENCY ARC PASSES ACROSS THE ELECTRODES IN THE LAMP IONIZING THE INSULATING XENON GAS CREATING A PATH FOR THE DISCHARGE OF CAPACITORS (C1, C2) THROUGH THE LAMP. AS THE CAPACITORS DISCHARGE THE CURRENT THROUGH THE LAMP INCREASES. THE CURRENT LIMITING RESISTOR (R1) STOPS THE EFFECT OF THE BOOST CIRCUIT ON THE OUTPUT OF THE POWER SUPPLY AS THE CURRENT INCREASES. AT THE SAME TIME THE MAIN POWER SUPPLY CONTINUES SUPPLYING REGULATED CONSTANT CURRENT TO THE LAMP. THE OUTPUT VOLTAGE OF THE MAIN POWER SUPPLY IS DETERMINED BY THE IMPEDANCE OF THE LAMP AFTER IT IS LIT.

THE RESISTOR (R3) LIMITS THE DISCHARGE CURRENT OF CAPACITORS (C1, C2) THROUGH THE LAMP DURING THE IGNITION CYCLE PREVENTING DAMAGE TO THE LAMP DUE TO EXCESSIVE CURRENT. ONCE THE OUTPUT VOLTAGE OF THE POWER SUPPLY HAS DROPPED TO THE NORMAL OPERATING LEVEL RELAY (K6) DE-ENERGIZES CONNECTING CAPACITORS (C1, C2) DIRECTLY TO THE POWER SUPPLY OUTPUT THEREBY INCREASING THEIR FILTERING CAPABILITY. ZENER DIODE (CR9) IS IN SERIES WITH THE COIL OF (K6) TO INSURE THAT RELAY (K6) RELEASES DURING THE LAMP OPERATION.

THE CIRCUIT BREAKER (CB1) MONITORS THE RIPPLE CURRENT ON THE OUTPUT OF THE POWER SUPPLY. WHEN THE LAMP IS RUNNING IF ONE OF THE THREE PHASE INPUT POWER LINES FAILS OR IF ONE OF THE RECTIFICATION OR FILTER COMPONENTS FAILS THE OUTPUT RIPPLE OF THE POWER SUPPLY WILL INCREASE SIGNIFICANTLY. WHEN THE RIPPLE CURRENT INCREASES THE CIRCUIT BREAKER WILL TRIP DE-ENERGIZING THE INPUT POWER CONTACTOR (K1) THEREBY PREVENTING DAMAGE TO THE LAMP FROM THE HIGH RIPPLE CURRENT.

THE THERMAL SWITCH (TS1) IS LOCATED ON THE POSITIVE HEATSINK AND MONITORS THE OUTPUT POWER DIODE TEMPERATURE. WHEN THE HEATSINK TEMPERATURE EXCEEDS THE SAFE MAXIMUM LIMIT FOR THE POWER DIODES THE SWITCH WILL OPEN DE-ENERGIZING THE INPUT POWER CONTACTOR (K1) THEREBY PREVENTING DAMAGE TO THE OUTPUT POWER DIODES FROM EXCESSIVE OPERATING TEMPERATURE.

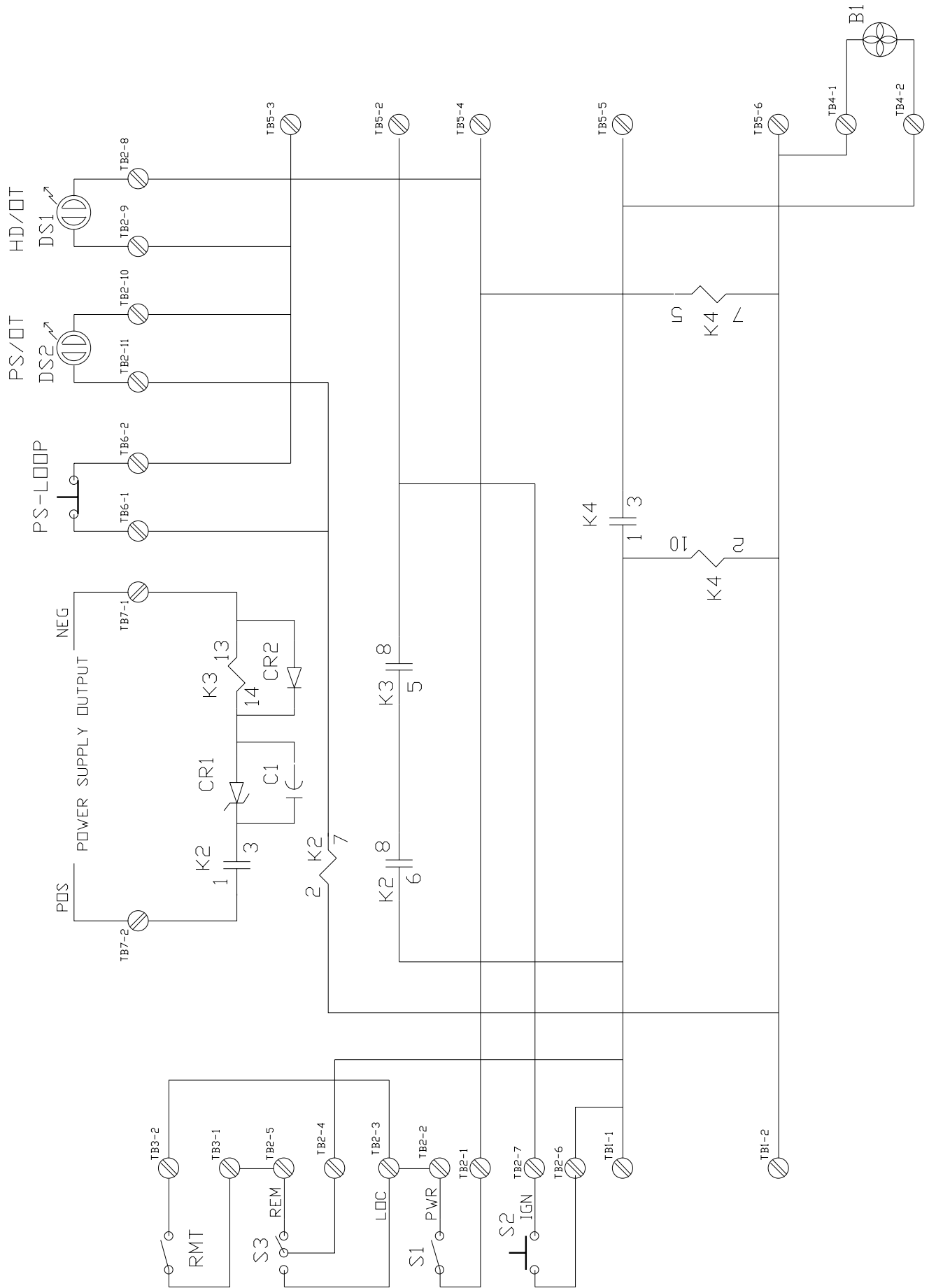

FIG-10 CONTROL PCB SCHEMATIC

AUTO STRIKE CIRCUIT THEORY OF OPERATION

WHEN THE CIRCUIT SUPPLYING POWER TO THE POWER SUPPLY MAIN CONTACTOR (K1) IS ENERGIZED CURRENT FLOWS THROUGH THE LAMP POWER SWITCH (S1) TO (TB2-1) OUT (TB5-3) THROUGH THE LAMP HEAD SAFETY INTERLOCK CIRCUIT RETURNS TO (TB5-3) OUT (TB6-2) TO POWER SUPPLY TERMINAL BLOCK (TB7-4) THROUGH THE POWER SUPPLY SAFETY INTERLOCK CIRCUIT (TS1,CB1) OUT (TB7-3) AND SPLITS OFF TO THE MAIN CONTACTOR COIL (K1) THROUGH (TB7-2) AND TO THE COIL OF THE AUTO STRIKE TIME LIMIT RELAY (K2).

THE AUTO STRIKE TIME LIMIT RELAY (K2) RESTRICTS THE OPERATION OF THE AUTO STRIKE CIRCUIT TO ONE MINUTE AFTER THE SYSTEM IS ENERGIZED BY OPENING THE CIRCUIT SUPPLYING POWER TO THE LAMP HEAD IGNITOR CIRCUIT (K2-6,8) AND OPENING THE CIRCUIT SUPPLYING POWER TO THE COIL OF THE AUTO STRIKE POWER RELAY (K3) (K2-1,3).

WHEN THE POWER SUPPLY IS ENERGIZED AND THE PRE IGNITION OUTPUT VOLTAGE IS ABOVE 85 VDC ZENER DIODE (CR11) BREAKS DOWN ALLOWING THE CURRENT TO FLOW THROUGH THE COIL OF THE AUTO STRIKE POWER RELAY (K3). WHEN THE AUTO STRIKE POWER RELAY (K3) ACTUATES CURRENT FLOWS THROUGH IT'S CONTACTS (K3-5,8) TO (TB5-2) AND OUT TO THE LAMP HEAD IGNITOR CIRCUIT. WHEN THE LAMP HEAD IGNITOR CIRCUIT ENERGIZES THE OUTPUT VOLTAGE OF THE POWER SUPPLY DROPS BELOW THE BREAK DOWN THRESHOLD OF ZENER DIODE (CR11) CAUSING THE AUTO STRIKE RELAY (K3) TO DE-ENERGIZE OPENING THE IGNITOR POWER CIRCUIT. IF THE LAMP LIGHTS THE OUTPUT VOLTAGE OF THE POWER SUPPLY WILL REMAIN BELOW THE BREAK DOWN THRESHOLD OF ZENER DIODE (CR11) AND THE AUTO STRIKE RELAY (K3) WILL REMAIN DE-ENERGIZED. IF THE LAMP DOES NOT LIGHT THE OUTPUT VOLTAGE OF THE POWER SUPPLY WILL RECYCLE TO ABOVE THE ZENER DIODE (CR11) BREAK DOWN THRESHOLD AND THE AUTO STRIKE POWER RELAY (K3) WILL REENERGIZE. THIS CYCLE WILL REPEAT UNTIL THE LAMP LIGHTS OR THE AUTO STRIKE TIME LIMIT RELAY (K2) TIMES OUT. ONCE THE TIME LIMIT IS REACHED THE AUTO STRIKE CIRCUIT WILL NOT OPERATE UNTIL THE CIRCUIT SUPPLYING POWER TO THE MAIN POWER SUPPLY CONTACTOR (K1) IS DE-ENERGIZED AND REENERGIZED. IF ONE OF THE SYSTEM SAFETY INTERLOCK CIRCUITS OPENS THE POWER SUPPLY CONTACTOR CIRCUIT, UPON RESETTING THE AUTO STRIKE CYCLE WILL REINITIALIZE.

SYSTEM COOL DOWN CIRCUIT THEORY OF OPERATION

WHEN THE SYSTEM MAIN POWER IS ENERGIZED THE CURRENT FLOWS FROM THE LINE SIDE OF THE POWER SUPPLY CONTACTOR (K1) THROUGH CIRCUIT BREAKER (CB3) TO AUTOTRANSFORMER (T2) WHERE THE 230 VAC LINE IS STEPPED DOWN TO 120 VAC. THE CURRENT FLOWS THROUGH CIRCUIT BREAKER (CB2) TO (TB1-1) TO THE SUPPLY INPUT (K4-10,2) AND POWER CONTACTS (K4-1,3) OF COOL DOWN TIMING RELAY (K4).

WHEN THE CIRCUIT SUPPLYING POWER TO THE POWER SUPPLY MAIN CONTACTOR (K1) IS ENERGIZED CURRENT FLOWS THROUGH THE LAMP POWER SWITCH (S1) TO (TB2-1) AND TO THE CONTROL INPUT OF COOL DOWN TIMING RELAY (K4-5,7). THE COOL DOWN TIMING RELAY (K4) ACTUATES CLOSING IT'S POWER CONTACTS (K4-1,3). CURRENT FLOWS TO (TB5-5) OUT TO THE LAMP HEAD COOLING CIRCUIT AND TO (TB4-2) OUT TO THE POWER SUPPLY COOLING FAN. WHEN THE CIRCUIT SUPPLYING TO THE POWER SUPPLY MAIN CONTACTOR (K1) IS DE-ENERGIZED THE REMOVAL OF POWER TO THE COOL DOWN TIMING RELAYS CONTROL INPUT (K4-5,7) CAUSES THE COOL DOWN TIMING RELAY (K4) TO START IT'S TIMING CYCLE. THIRTY MINUTES AFTER THE CONTROL INPUT IS DE-ENERGIZED THE COOL DOWN TIMING RELAY (K4) WILL OPEN IT'S POWER CONTACTS (K4-1,3) DE-ENERGIZING THE LAMP HEAD AND POWER SUPPLY COOLING CIRCUITS.

SYSTEM PART LISTS

LAMP HEAD MAIN BULKHEAD ASSY

XE PT NO	DESCRIPTION	REFERANCE DESIGNATOR
843-0006	GROMMET STRIP 1/8' BLK	
972-0047	ASSY PLENUM	
972-0032	ASSY AIR PRESSURE SW	S5
710-0061	SWITCH THERMAL 300 DEG	S2
972-0033	ASSY RECEIVER	
972-0036	ASSY WIRE HARNESS MAIN	
972-0037	ASSY BLOWER	B1,C8
972-0038	ASSY XFMR IGN PRIMARY	T2
942-0014	ASSY RF CHOKE	L1,C3
972-0039	ASSY XFMR IGNITOR RF	T1,C2,C4
710-0044	SW SPARK GAP	E1
132-2410	CAP CER 2400 pF 20KV	C1
338-2637	SCR 8-32 X 1/4 PHSL BRS	
329-0827	WSHR #8 INT STAR BRZ	
725-0008	TERM BLK MARATHON 1422572	
341-6223	SCR 10-32 x 5/8 PHP BLK	
329-1011	WSHR #10 SPLIT SST	
329-1001	WSHR #10 FL SST	
972-0040	ASSY TERM BLK 8 POS	
972-0041	ASSY JUMPER BLKHD-SPIDER	
972-0042	ASSY JUMPER BLKHD-TB POS	
972-0043	ASSY JUMPER BLKHD-TB NEG	
900-0001	ASSY PCB HOUR METER	
323-0014	HDW CABLE TIE 4	
350-7511	BOLT 1/4-20 X 3/4 HEX SST	
329-2511	WSHR 1/4 SPLIT SST	
329-2501	WSHR 1/4 FL SST	

LAMP HEAD CORE ASSY

972-0030	ASSY REFLECTOR CCT 20 IN
972-0044	ASSY FRONT SPIDER
942-0005	ASSY LAMP HOLDER 4/7K
972-0045	ASSY FOCUS MANUAL
390-0400	GLOBE, 7KW XE4000-TH

LAMP HEAD COVERS

972-0026	ASSY COVER BOTTOM
972-0046	ASSY COVER REAR MAN FOCUS 4K-AR
972-0028	ASSY COVER TOP 4K-AR
680-2770	FAB RAIL SLIDE 4&7K
972-0029	FAB BAIL PLATE MTG
972-0025	ASST COWL FRONT

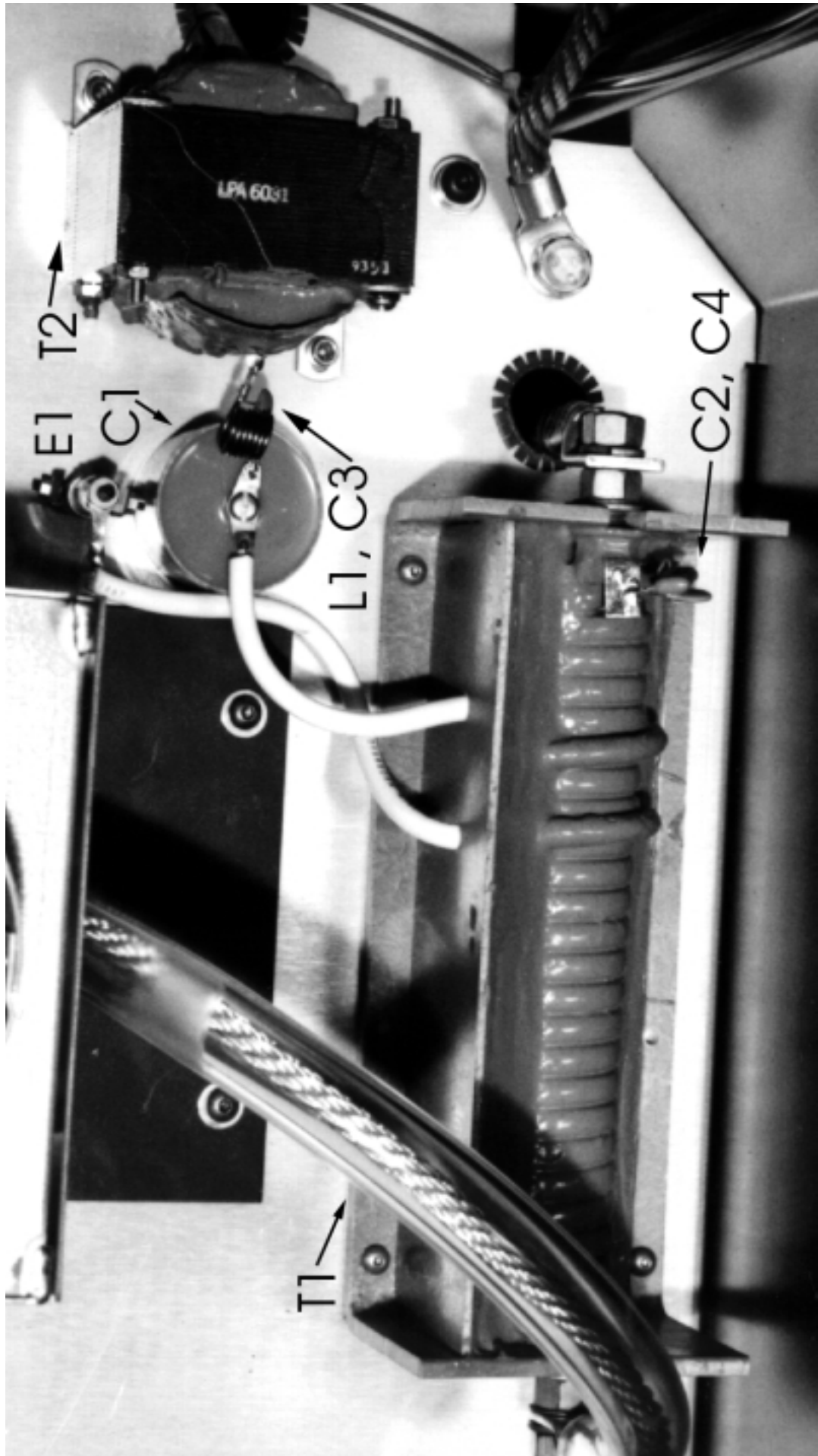

FIG-11 LAMP HEAD IGNITOR COMPONENT LOCATION

**BALLAST COVER ASSEMBLY
(SEE FIGURE3)**

XE PT NO	DESCRIPTION	REFERANCE DESIGNATOR
530-0025	POWER SUPPLY 150W 24 VDC	PS 1
343-0510	SCR M3-5 PHSL	
328-0310	WSHR M3 SPLIT SST	
328-0300	WSHR M3 FL SST	
900-0012	ASSY PCB SUPV TIMER IGN / CLG	
320-0801	STANDOFF 8-32 X 1/2 M/F	
338-6223	SCR 8-32 x 5/8 PHP BLK	
329-0811	WSHR #8 SPLIT SST	
329-0801	WSHR #8 FL SST	
330-1101	NUT 10-32 SST	
771-0006	CURRENT SHUNT 200 A 200MV	R4
341-6223	SCR 10-32 x 5/8 PHP BLK	
329-1011	WSHR #10 SPLIT SST	
329-1001	WSHR #10 FL SST	
330-1101	NUT 10-32 SST	
725-0008	TERM BLK MARATHON 1422572	TB 10
341-6223	SCR 10-32 x 5/8 PHP BLK	
329-1011	WSHR #10 SPLIT SST	
329-1001	WSHR #10 FL SST	
330-1101	NUT 10-32 SST	
725-0024	TERM BLK 16 POS COMMONING	TB 9
336-1021	SCR 6-32 X 1 PHP SST	
329-0611	WSHR #6 SPLIT SST	
329-0601	WSHR #6 FL SST	
330-0600	NUT 6-32 SST	
972-0040	TERM BLK 8 POS	TB 11
341-6223	SCR 10-32 x 5/8 PHP BLK	
329-1011	WSHR #10 SPLIT SST	
329-1001	WSHR #10 FL SST	
330-1101	NUT 10-32 SST	

BALLAST CONTROL PANEL ASSEMBLY

XE PT NO	DESCRIPTION	REFERENCE DESIGNATOR
323-0071	HDW BANANA SKT RED	TP 1, 3
323-0069	HDW BANANA SKT BLK	TP 2, 4
899-0011	IND NEON RED 125V	DS 1, 2
899-0013	IND NEON GRN 125V	DS 3, 4
710-0033	SWTOGGLE DPDT	S 1, 3
560-0020	CB 2 A RECIR KD1-2	CB 3
560-0052	CB 5 A RECIR KD1-5	CB 2
560-9997	CB CLIP RECIRCUIT	CB 2, 3
710-0014	SW PUSHBUTTON SPST N/O	S 2

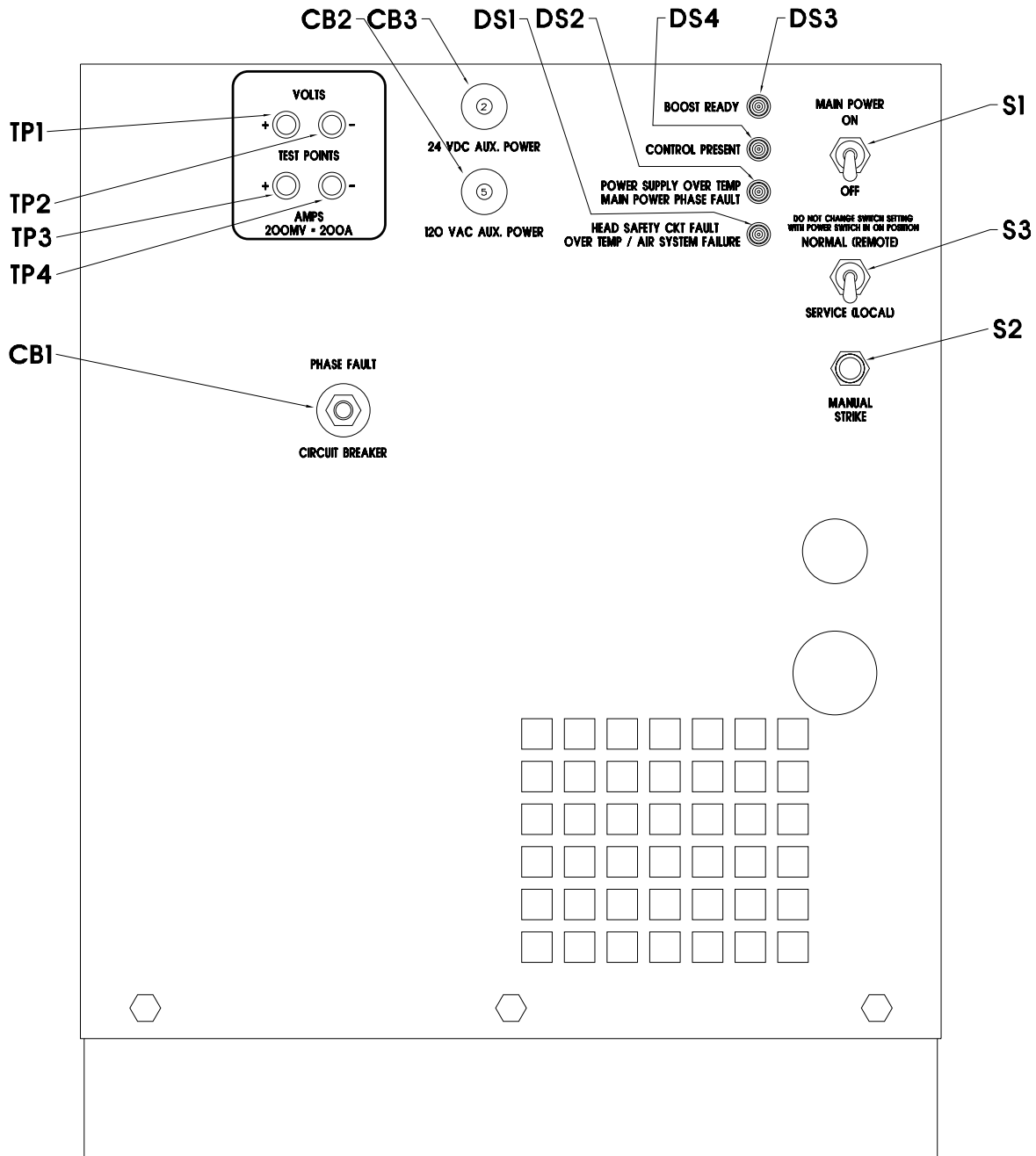

FIG-12 BALLAST CONTROL COMPONENT LOCATION

BALLAST CONTROL PRINTED CIRCUIT BOARD

XE PT NO	DESCRIPTION	REFERENCE DESIGNATOR
190-0041	PCB SUPV TIMER IGN / CLG	
725-0013	TERM BLK 2 POS PCB 5MM SP	TB1,4,3,7,
725-0014	TERM BLK 3 POS PCB 5MM	TB5,6
725-0016	TERM BLK 12 POS PCB 5MM	TB2
590-0033	RELAY HOLD DOWN IDEC SY4S	K3
591-0007	RELAY SKT 11 PIN PC MNT	K4
591-0012	RELAY SKT 8 PIN PC MNT	K2
591-0009	RELAY SKT SH1B-62 PC MNT	K3
590-0032	RELAY SPDT 10A 120 VAC	K3
590-0022	RELAY OFF DLY PWRD 30 MIN 120V	K4
590-0019	RELAY INTVL 1MIN 120 VAC/DC	K2
653-4007	DIO GEN PUR 1A 1000V 1N4007	CR2
656-5100	DIO ZENER 51V 5W 1N5369A	CR1
133-5010	CAP CER .005 uF 1KV	C1

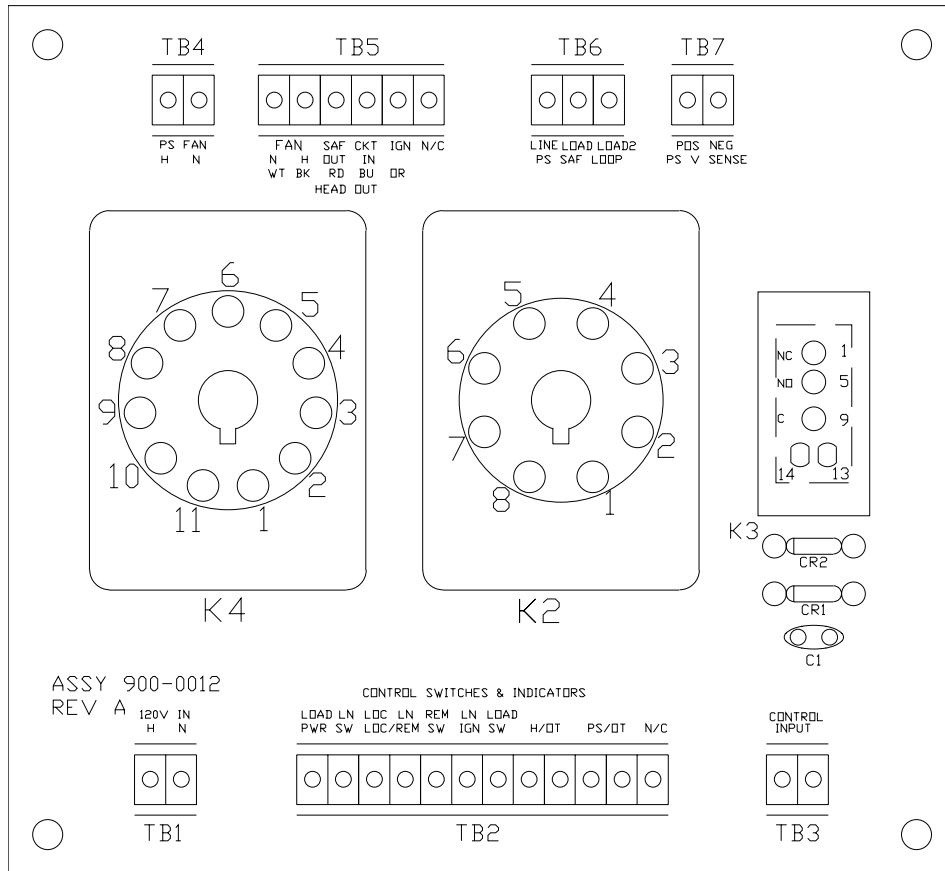

FIG-13 CONTROL PCB COMPONENT LOCATION

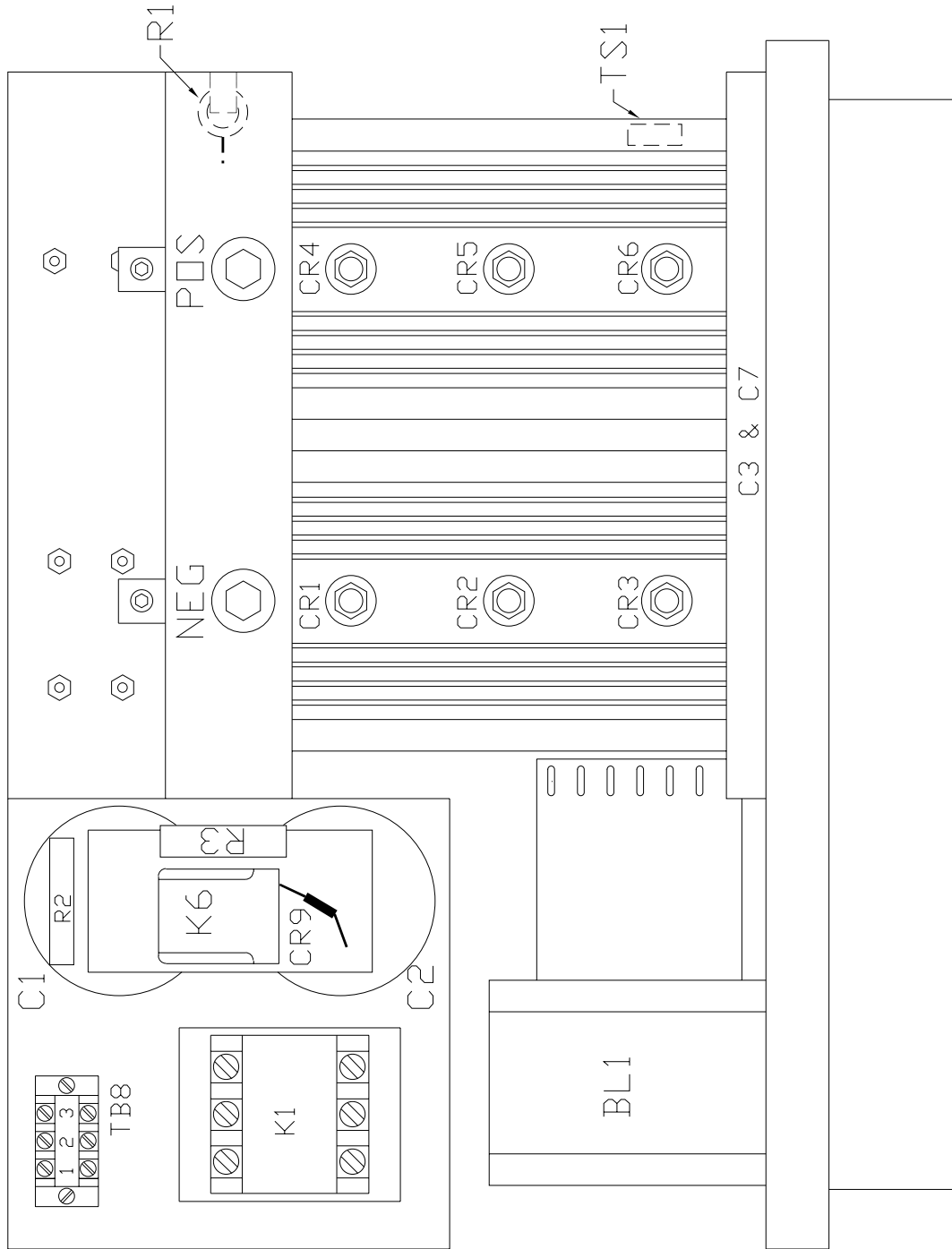

FIG-14 BALLAST CORE COMPONENT LOCATION

POWER SUPPLY ASSY PART LIST

XENOTECH P/N	PART DESCRIPTION	REF DES
530-0016	BALLAST CORE 4KW 208/230V	
653-4007	DIODE, 1 AMP 400V	CR7,8
133-5010	CAPACITOR .005 uF 1KV CERAMIC	C4-7
139-4990	CAPACITOR 4900 uF. 150 VDC	C1,C2
135-4740	CAPACITOR, .47uF 250V	C3
653-0001	DIODE, POWER 1N3291A	CR4-6
653-0002	DIODE, POWER 1N3291R	CR1-3
656-3600	ZENER DIODE 36V 5W	CR9
555083-601	RESISTOR 8K OHM 10 WATT W/W	R2
555258-801	RESISTOR .25 OHM 20W W/W	R3
555850-001	RESISTOR 85 OHM 100W W/W	R1
571220-001	RELAY, DPDT 20 AMP W/120 VAC COIL	K6
560-0080	CIRCUIT BREAKER 8 AMP 1 POLE W/AUX SWITCH	CB1
590-3000	CONTACTOR, 3PDT 30 AMP W/120 VAC COIL	K1
578811-002	SWITCH, THERMAL 225 DEG F N/C	TS1
725-0011	TERMINAL BLOCK 1 SECTION 40 AMP	TB8
725-0006	TERMINAL BLOCK 4 SECTION 70 AMP	TB1-6
300-0036	BLOWER 148 CFM 120 VAC	B1